

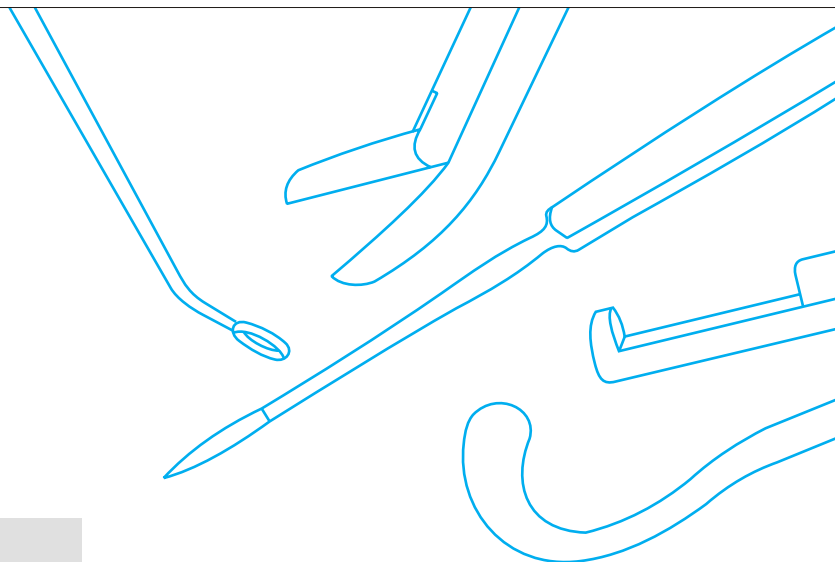

**SUAVE**<sup>®</sup>  
SURGICAL INSTRUMENTS



NS



## NEUROSURGERY

Neurosurgery deals with the diagnosis and treatment of pathological processes, which affect the nervous system. It includes the operative, non-operative, intensive care management and rehabilitation of patients with disorders affecting the brain and skull, spine and nervous system.

Perfection is in high demand in this discipline and requires talent, expertise and precision instrument manufacturing. At **Surtex** we support the skilled hands of the surgeon with high quality instruments for perfect surgical work.

Our neurosurgery instruments include but are not limited to the following Special Micro- Neurosurgical Instruments, Special Microsurgical Tube- shaft Instruments, Head-Cranio Instruments and Holding Systems, Pituitary Instruments, Self- retaining Retractors, Spine Instruments, Rongeurs and Laminectomy Punches, Vessel- and Bulldog- Clamps, Vessel Clips, General Surgical Instruments, Neuro-Orthopedic Instruments and Headrest systems to fix the patient's head and flexible Leyla retractor systems.

- Neurochirurgie
- Neurocirugía
- Neurochirurgie
- Neurochirurgia

Self-Retaining Brain Retractor  
Selbsthaltender Hirnretraktor  
Separador cerebral autostatico  
Retracteur cérébrale autostatique  
Retrattore celebrale autostatico

**Yasargil (Leyla) Brain Retractor Single Arm Complete**

Catalog #	Size
NS-010-01	N/A



**Yasargil (Leyla) Brain Double Retractor Arm Complete**

Catalog #	Size
NS-010-02	N/A



**Yasargil (Leyla) Flexible Arm**

Catalog #	Size
NS-010-10	N/A

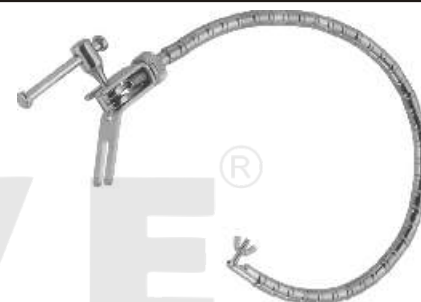

**Yasargil (Leyla) Flexible Base**

Catalog #	Size
NS-010-21	N/A
NS-010-22	N/A
NS-010-30	N/A



NS-010-21



NS-010-22



NS-010-30

**Yasargil (Leyla) Support for Round Spatulas**

Catalog #	Size
NS-010-40	N/A



**Yasargil (Leyla) Support for Flat Spatulas**



Catalog #	Size
NS-010-45	N/A

**Yasargil (Leyla) Ball and Socket Joint**



Catalog #	Size
NS-012-09	9 x 32 mm
NS-012-10	10 x 25 mm

**Yasargil (Leyla) Holding Rod**



Catalog #	Size
NS-012-20	N/A

**Yasargil (Leyla) Coupling Head**



Catalog #	Size
NS-012-25	N/A
NS-012-40	N/A

NS-012-25

NS-012-40

**Caspar Vertebral Distractor**

Right



Catalog #	Size
NS-020-01	N/A



Vertebrales distractor  
Vertébrale distracteur  
Vertebrale distrattore

**Caspar Drill Guide**

Right



Catalog #	Size
NS-020-02	N/A

**Caspar Vertebral Distractor**

Left



Catalog #	Size
NS-022-01	N/A

**Caspar Drill Guide**

Left



Catalog #	Size
NS-022-02	N/A

**Caspar Twist Drill**



Catalog #	Size
NS-024-00	14.5 cm (5 1/2)

**Caspar Distraction Screw**



Catalog #	Working End
NS-026-14	14 mm
NS-026-16	16 mm
NS-026-18	18 mm



**Casper Screw Driver**



Catalog #	Size
NS-028-20	20 cm (8)

**Gigli Wire Saw**

Catalog #	Size
NS-050-30	30 cm (11 ¾ )
NS-050-40	40 cm (11 ¾ )
NS-050-50	50 cm (11 ¾ )
NS-050-60	60 cm (11 ¾ )
NS-050-70	70 cm (11 ¾ )

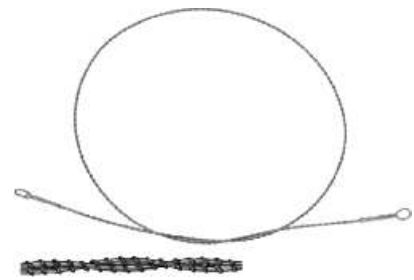

**Gigli Wire Saw Handle**

Catalog #	Size
NS-055-00	N/A

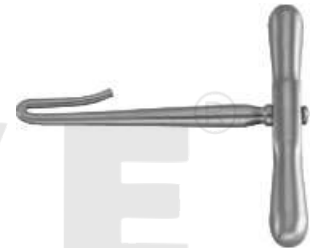

**De Martel Wire Saw Guide**

Catalog #	Size
NS-058-00	33 cm (13)



**Crutchfield Skull Traction Tongs**

Small Pattern

Catalog #	Size
NS-061-01	N/A



Estribos de tracción craneal  
Pinces de traction crânienne  
Pinze per trazione craniale

**Crutchfield Skull Traction Tongs**

Medium Pattern



Catalog #	Size
NS-061-02	N/A

**Crutchfield Drill Point**

Catalog #	Size, Diameter
NS-065-35	7 cm (2 ¾), Ø 3.5 mm
NS-065-50	7 cm (2 ¾), Ø 5.0 mm



**Skull Traction Tongs**

Large Pattern

Catalog #	Size
NS-071-00	N/A



**Spare Pin**

Catalog #	Size
NS-075-01	N/A



**Wrench**

Catalog #	Size
NS-075-02	N/A



**Dahlgren Cranial Rongeur**

Catalog #	Size
NS-091-20	20 cm (8)



**De Vibiss Cranial Rongeur**

Catalog #	Size
NS-093-21	20.5 cm (8)



**Cone Cranial Punch**

Catalog #	Size
NS-095-22	22.5 cm (8 ¾)



**Raney Scalp Clip**

Catalog #	Size
NS-100-00	N/A



**Raney Applying - Removal Forcep**

Catalog #	Size
NS-102-00	15.5 cm (6)



Grapas y pinzas aplicadoras  
Clips et pincers pour appliquer  
Agrafes e pinze per applicare

**McKenzie Clip Applying Forcep**

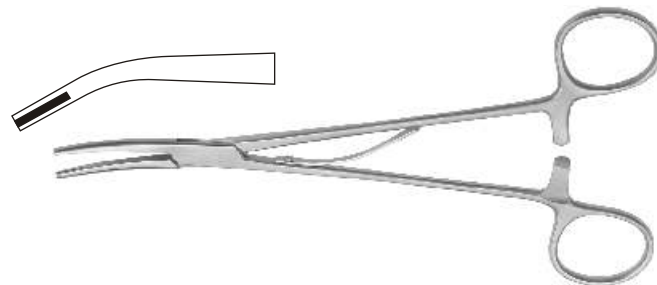

Catalog #	Size
NS-112-19	18.5 cm (7 1/4)

**Olivecrona-Toennis Clip Applying Forcep**

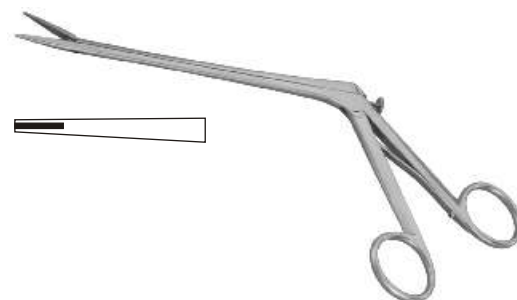

Catalog #	Size, Shaft Length
NS-115-14	N/A, 140 mm

**Silver Brain Clip**

Pack of 100



Catalog #	Size
NS-118-00	N/A

**Yasargil Galea Hook**



Catalog #	Size
NS-120-01	N/A
NS-120-02	N/A

**Davis Dura Dissector**



Catalog #	Size
NS-151-21	21.5 cm (8 1/2)

**Davis Dura Dissector**



Catalog #	Size
NS-153-24	24.5 cm (9 ¾)

**Frazier Dura Dissector**

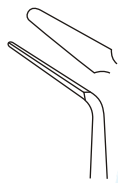

Catalog #	Size
NS-155-01	15 cm (6)

**Hoehn Dura Dissector**

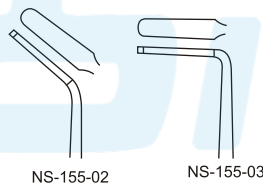

Catalog #	Size
NS-155-02	15 cm (6)
NS-155-03	15 cm (6)



**Love-Adson Dura Dissector**



Catalog #	Size
NS-157-16	16 cm (6 ½)

**Toennis Dura Dissector**



Catalog #	Size
NS-159-26	26 cm (10 ¼)





Disecadores para duramadre  
Dissecteurs à dure-mère  
Dissettori per la dura-madre

**Olivecrona Dura Dissector**



Catalog #	Size
NS-161-01	24 cm (9 1/2)

**Olivecrona Dura Dissector**



Catalog #	Size
NS-161-02	18 cm (7)

**Olivecrona Dura Dissector**



Catalog #	Size
NS-161-03	24 cm (9 1/2)

**Olivecrona Dura Dissector**



Catalog #	Size
NS-161-04	20 cm (8)

**Sachs Dura Dissector**

Sharp



Catalog #	Size
NS-163-21	20 cm (8)



**Milligan Dura Dissector**



Catalog #	Size
NS-165-21	21.5 cm (8 ½)

**Dura Dissector**



Catalog #	Size
NS-167-22	22 cm (8 ¾)

**Penfield Dura Dissector**



Catalog #	Size, Profile
NS-171-01	17.5 cm (7), F ig. 1

**Penfield Dura Dissector**



Catalog #	Size, Profile
NS-171-02	19.5 cm (7 ¾) , Fig. 2

**Penfield Dura Dissector**



Catalog #	Size, Profile
NS-171-03	19.5 cm (7 ¾) , Fig. 3



Disecadores para duramadre  
Dissecteurs à dure-mère  
Dissettori per la dura-madre

**Penfield Dura Dissector**



Catalog #	Size, Profile
NS-171-04	20.5 cm (8), F ig. 4

**Penfield Dura Dissector**

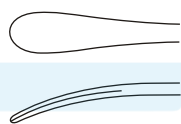

Catalog #	Size, Profile
NS-171-05	18 cm (7), F ig. 5

**Horsley Dura Elevator**



Catalog #	Size
NS-181-20	20 cm (8)

**Sachs Dura Elevator**



Catalog #	Size
NS-183-21	21 cm (8 ¼ )

**Love Nerve Root Retractor**

Straight



Catalog #	Size
NS-190-21	21.5 cm (8 ½)

**Love Nerve Root Retractor**

Angled 45°



Catalog #	Size
NS-191-18	17.5 cm (7)

**Love Nerve Root Retractor**

Angled 90°

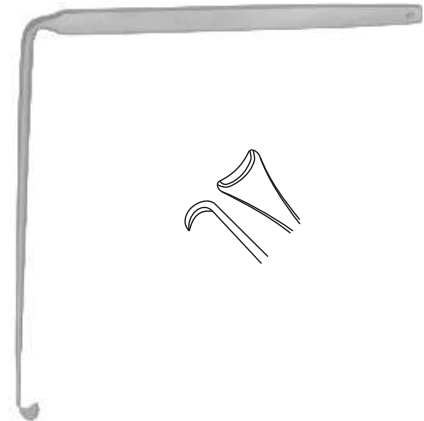

Catalog #	Size
NS-193-11	11 cm (4 1/4 )

**Love Nerve Root Retractor**



Catalog #	Size
NS-195-21	22 cm (8 3/4 )

**Hess Nerve Root Retractor**



Catalog #	Size, Width
NS-197-03	17.5 cm (7), 3 mm
NS-197-05	17.5 cm (7), 5 mm
NS-197-07	17.5 cm (7), 7 mm

**Scoville Nerve Root Retractor**



Catalog #	Size
NS-200-23	23.5 cm (9 1/4 )



Separadores para la raíz de nervio  
Retracteurs pour racines nerveuses  
Uncini per le radici die nervi

**Holsher Nerve Root Retractor**



Catalog #	Size
NS-201-24	23.5 cm (9 1/4 )

**Scoville Nerve Root Retractor**



Catalog #	Size
NS-203-19	16.5 cm (6 1/2)

**Cushing Brain Spatulas**



Catalog #	Size, Blade Size
NS-210-07	18 cm (7), 7 + 9 mm
NS-210-11	18 cm (7), 1 1 + 13 mm
NS-210-15	18 cm (7), 1 5 + 18 mm
NS-210-18	18 cm (7), 1 8 + 22 mm

**Olivecrona Brain Spatulas**

Concave



Catalog #	Size, Blade Size
NS-213-07	18 cm (7), 7 + 9 mm
NS-213-11	18 cm (7), 1 1 + 13 mm
NS-213-15	18 cm (7), 1 5 + 18 mm
NS-213-18	18 cm (7), 1 8 + 22 mm



**Olivecrona Brain Spatulas**

Convex

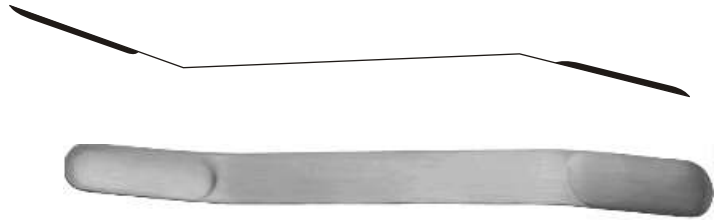

Catalog #	Size, Blade Size
NS-215-07	18 cm (7), 7 + 9 mm
NS-215-11	18 cm (7), 1 1 + 13 mm
NS-215-15	18 cm (7), 1 5 + 18 mm
NS-215-18	18 cm (7), 1 8 + 22 mm

**Heifetz Brain Spatulas**

Catalog #	Size, Blade Size
NS-218-07	20 cm (8), 7 + 8 mm
NS-218-10	20 cm (8), 1 0 + 11 mm
NS-218-13	20 cm (8), 1 3 + 14 mm
NS-218-15	20 cm (8), 1 5 + 17 mm
NS-218-19	20 cm (8), 1 9 + 20 mm
NS-218-22	20 cm (8), 2 2 + 22 mm



**Heifetz Brain Spatulas**

Round Handle

Catalog #	Size, Blade Size
NS-221-08	20 cm (8), 8 mm
NS-221-11	20 cm (8), 1 1 mm
NS-221-14	20 cm (8), 1 4 mm
NS-221-17	20 cm (8), 1 7 mm
NS-221-20	20 cm (8), 2 0 mm



**Brain Spatulas**

Malleable



Catalog #	Size
NS-224-12	20 cm (8), 1 2 mm
NS-224-17	20 cm (8), 1 7 mm



Ganchos para nervios  
Crochets à nerfs  
Uncini per nervi

**Smithwick Nerve Hook**



Catalog #	Size
NS-231-17	17 cm (6 ¾)

**Smithwick Nerve Hook**



Catalog #	Size
NS-233-21	21 cm (8 ¼ )

**Adson Dura Hook**



Catalog #	Size
NS-235-20	20 cm (8)

**Graham Dura Hook**

Blunt



Catalog #	Size
NS-237-16	16.5 cm (6 ½)

**Sachs Dura Hook**

Sharp



Catalog #	Size
NS-239-18	18 cm (7)



**Frazier Dura Hook**

Sharp



Catalog #	Size
NS-241-18	18 cm (7)

**Hoehn Nerve Retractor**



Catalog #	Size
NS-245-22	22 cm (8 ¾)

**Dandy Nerve Retractor**



NS-251-01



NS-251-02



NS-251-03

Catalog #	Size
NS-251-01	20 cm (8)
NS-251-02	20 cm (8)
NS-251-03	20 cm (8)

**Smithwick Nerve Retractor**



Catalog #	Size
NS-253-29	29 cm (11 ½ )

**Toennis Nerve Retractor**



Catalog #	Size
NS-261-15	15 cm (6)

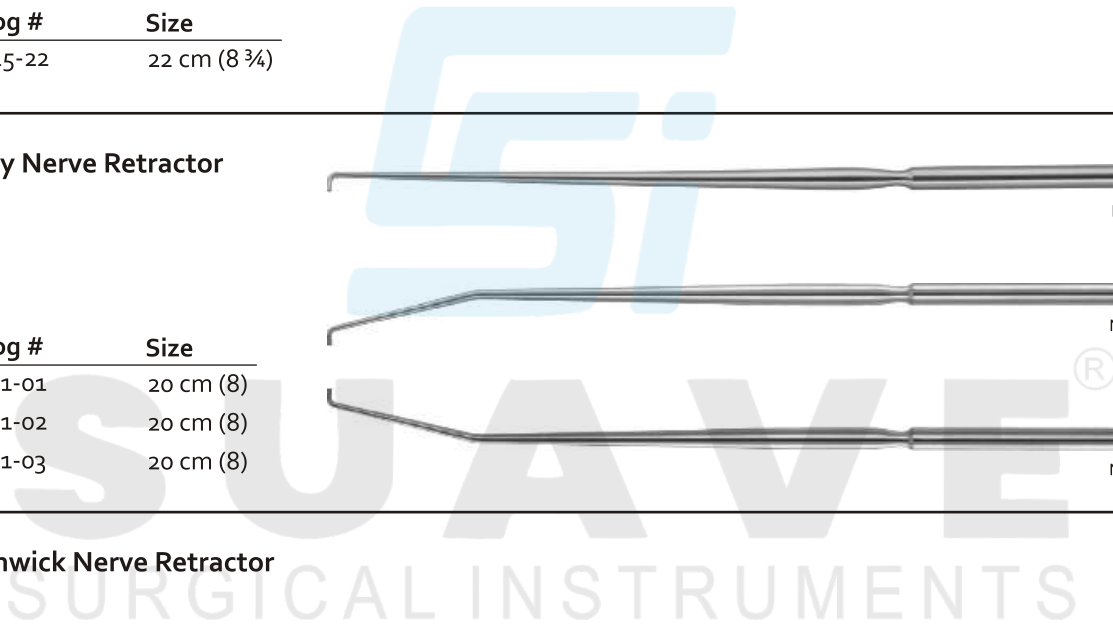

Bisturís para duramadre, Pinzas cortantes para laminectomía  
Bistouries pour duremère, Pincas emporte-pièces à laminectomie  
Bisturi per duramadre, Pinze taglienti per laminectomia

**Toennis Brain Knife**



Catalog #	Size
NS-280-18	18 cm (7)

**Halle Brain Knife**



Catalog #	Size
NS-282-20	20 cm (8)

**Ferris-Smith Kerrison Rongeur**

Up Cutting



Catalog #	Size, Bite Size
NS-300-01	15 cm (6), 1 mm
NS-300-02	15 cm (6), 2 mm
NS-300-03	15 cm (6), 3 mm
NS-300-04	15 cm (6), 4 mm
NS-300-05	15 cm (6), 5 mm

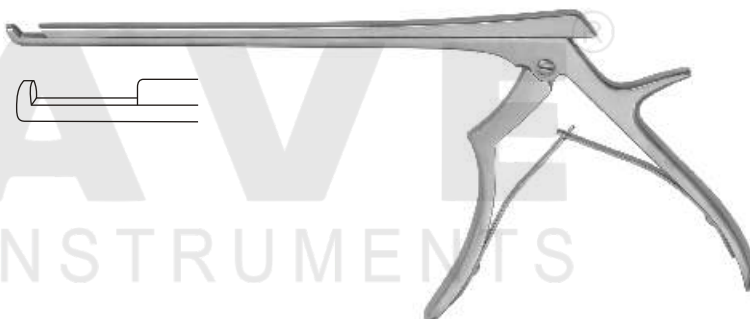

**Ferris-Smith Kerrison Rongeur**

Down Cutting



Catalog #	Size, Bite Size
NS-301-01	15 cm (6), 1 mm
NS-301-02	15 cm (6), 2 mm
NS-301-03	15 cm (6), 3 mm
NS-301-04	15 cm (6), 4 mm
NS-301-05	15 cm (6), 5 mm

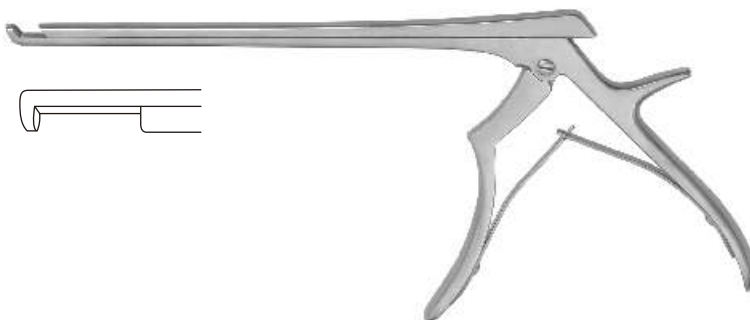

**Ferris-Smith Kerrison Rongeur**

40° Forward Up Cutting



Catalog #	Size, Bite Size
NS-302-01	15 cm (6), 1 mm
NS-302-02	15 cm (6), 2 mm
NS-302-03	15 cm (6), 3 mm
NS-302-04	15 cm (6), 4 mm
NS-302-05	15 cm (6), 5 mm

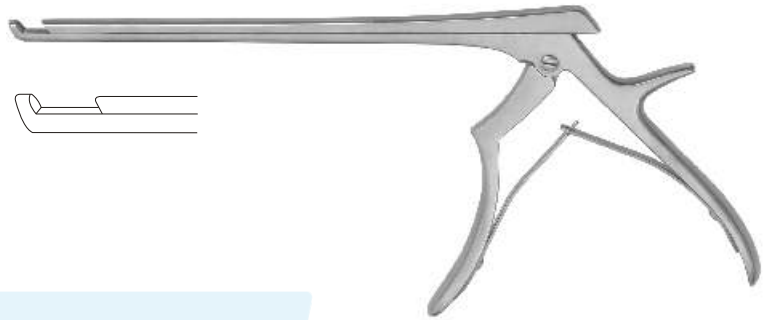

**Ferris-Smith Kerrison Rongeur**

40° Forward Down Cutting



Catalog #	Size, Bite Size
NS-303-01	15 cm (6), 1 mm
NS-303-02	15 cm (6), 2 mm
NS-303-03	15 cm (6), 3 mm
NS-303-04	15 cm (6), 4 mm
NS-303-05	15 cm (6), 5 mm

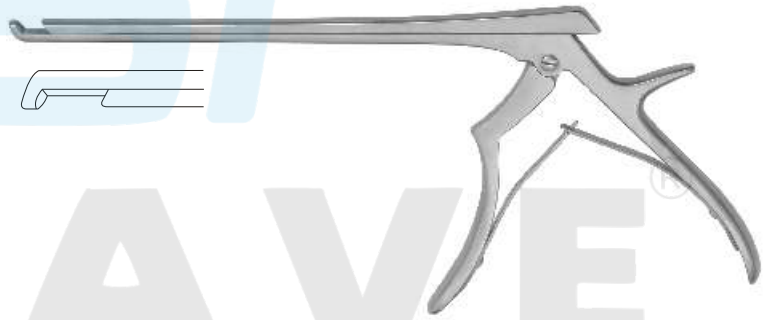

**Ferris-Smith Kerrison Rongeur**

Up Cutting



Catalog #	Size, Bite Size
NS-304-01	18 cm (7), 1 mm
NS-304-02	18 cm (7), 2 mm
NS-304-03	18 cm (7), 3 mm
NS-304-04	18 cm (7), 4 mm
NS-304-05	18 cm (7), 5 mm

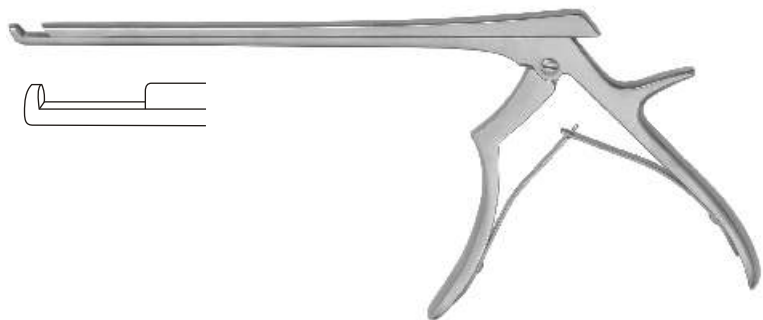

Pinzas cortantes para laminectomía  
Pincès emporte-pièces à laminectomie  
Pinze taglianti per laminectomia

**Ferris-Smith Kerrison Rongeur**

Down Cutting



Catalog #	Size, Bite Size
NS-305-01	18 cm (7), 1 mm
NS-305-02	18 cm (7), 2 mm
NS-305-03	18 cm (7), 3 mm
NS-305-04	18 cm (7), 4 mm
NS-305-05	18 cm (7), 5 mm

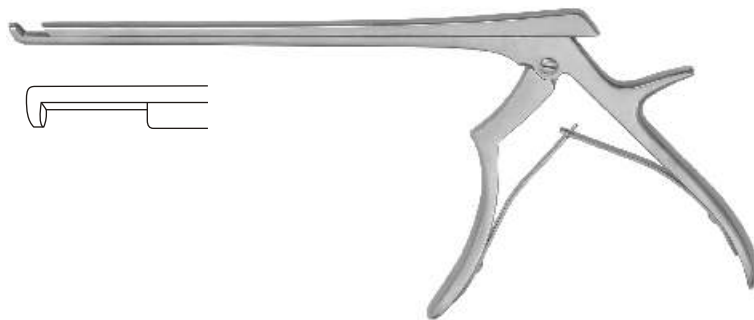

**Ferris-Smith Kerrison Rongeur**

40° Forward Up Cutting



Catalog #	Size, Bite Size
NS-306-01	18 cm (7), 1 mm
NS-306-02	18 cm (7), 2 mm
NS-306-03	18 cm (7), 3 mm
NS-306-04	18 cm (7), 4 mm
NS-306-05	18 cm (7), 5 mm



**Ferris-Smith Kerrison Rongeur**

40° Forward Down Cutting



Catalog #	Size, Bite Size
NS-307-01	18 cm (7), 1 mm
NS-307-02	18 cm (7), 2 mm
NS-307-03	18 cm (7), 3 mm
NS-307-04	18 cm (7), 4 mm
NS-307-05	18 cm (7), 5 mm

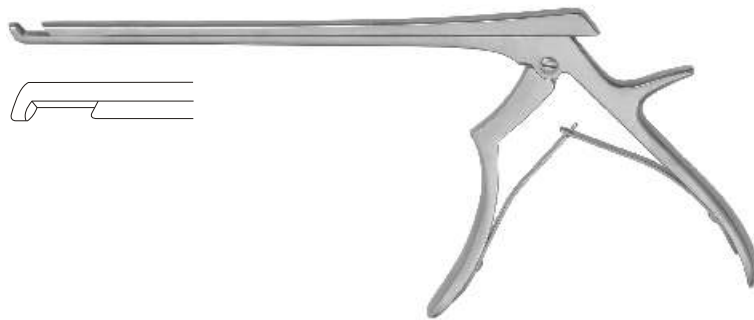

**Ferris-Smith Kerrison Rongeur**

Up Cutting

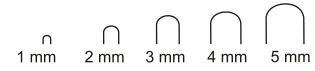

Catalog #	Size, Bite Size
NS-308-01	20 cm (8), 1 mm
NS-308-02	20 cm (8), 2 mm
NS-308-03	20 cm (8), 3 mm
NS-308-04	20 cm (8), 4 mm
NS-308-05	20 cm (8), 5 mm

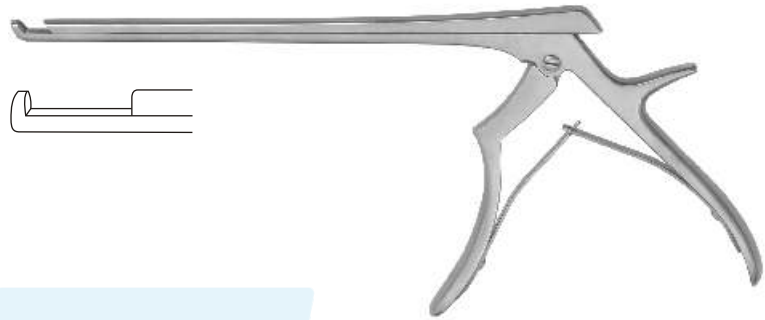

**Ferris-Smith Kerrison Rongeur**

Down Cutting

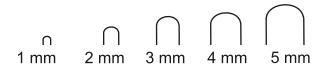

Catalog #	Size, Bite Size
NS-309-01	20 cm (8), 1 mm
NS-309-02	20 cm (8), 2 mm
NS-309-03	20 cm (8), 3 mm
NS-309-04	20 cm (8), 4 mm
NS-309-05	20 cm (8), 5 mm

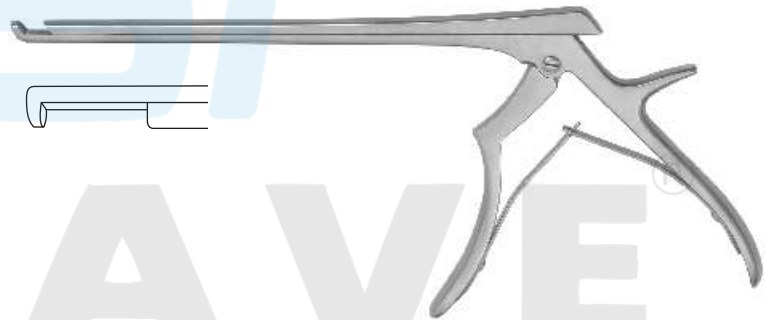

**Ferris-Smith Kerrison Rongeur**

40° Forward Up Cutting



Catalog #	Size, Bite Size
NS-310-01	20 cm (8), 1 mm
NS-310-02	20 cm (8), 2 mm
NS-310-03	20 cm (8), 3 mm
NS-310-04	20 cm (8), 4 mm
NS-310-05	20 cm (8), 5 mm





Pinzas cortantes para laminectomía  
Pinces emporte-pièces à laminectomie  
Pinze taglianti per laminectomia

**Ferris-Smith Kerrison Rongeur**

40° Forward Down Cutting



Catalog #	Size, Bite Size
NS-311-01	20 cm (8), 1 mm
NS-311-02	20 cm (8), 2 mm
NS-311-03	20 cm (8), 3 mm
NS-311-04	20 cm (8), 4 mm
NS-311-05	20 cm (8), 5 mm

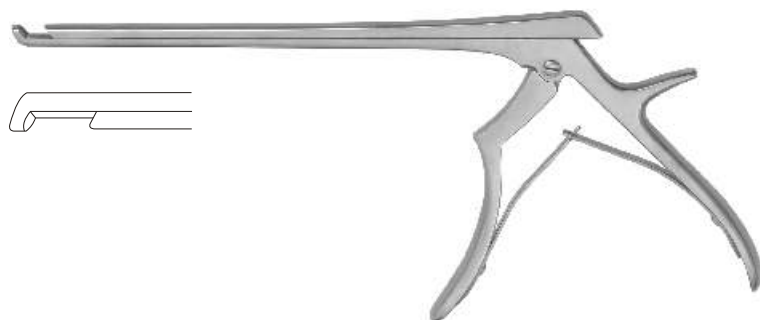

**Ferris-Smith Kerrison Rongeur**

Detachable Model, Up Cutting



Catalog #	Size, Bite Size
NS-320-01	18 cm (7), 1 mm
NS-320-02	18 cm (7), 2 mm
NS-320-03	18 cm (7), 3 mm
NS-320-04	18 cm (7), 4 mm
NS-320-05	18 cm (7), 5 mm



**Ferris-Smith Kerrison Rongeur**

Detachable Model, Down Cutting



Catalog #	Size, Bite Size
NS-321-01	18 cm (7), 1 mm
NS-321-02	18 cm (7), 2 mm
NS-321-03	18 cm (7), 3 mm
NS-321-04	18 cm (7), 4 mm
NS-321-05	18 cm (7), 5 mm





**Ferris-Smith Kerrison Rongeur**

Detachable Model, 40° Forward Up Cutting



Catalog #	Size, Bite Size
NS-322-01	18 cm (7), 1 mm
NS-322-02	18 cm (7), 2 mm
NS-322-03	18 cm (7), 3 mm
NS-322-04	18 cm (7), 4 mm
NS-322-05	18 cm (7), 5 mm

**Ferris-Smith Kerrison Rongeur**

Detachable Model, 40° Forward Down Cutting

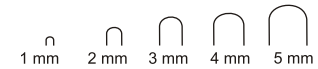

Catalog #	Size, Bite Size
NS-323-01	18 cm (7), 1 mm
NS-323-02	18 cm (7), 2 mm
NS-323-03	18 cm (7), 3 mm
NS-323-04	18 cm (7), 4 mm
NS-323-05	18 cm (7), 5 mm

**Ferris-Smith Kerrison Rongeur**

Detachable Model, Up Cutting



Catalog #	Size, Bite Size
NS-324-01	20 cm (8), 1 mm
NS-324-02	20 cm (8), 2 mm
NS-324-03	20 cm (8), 3 mm
NS-324-04	20 cm (8), 4 mm
NS-324-05	20 cm (8), 5 mm

Pinzas cortantes para laminectomía  
Pincès emporte-pièces à laminectomie  
Pinze taglianti per laminectomia

**Ferris-Smith Kerrison Rongeur**

Detachable Model, Down Cutting

Catalog #	Size, Bite Size
NS-325-01	20 cm (8), 1 mm
NS-325-02	20 cm (8), 2 mm
NS-325-03	20 cm (8), 3 mm
NS-325-04	20 cm (8), 4 mm
NS-325-05	20 cm (8), 5 mm



**Ferris-Smith Kerrison Rongeur**

Detachable Model, 40° Up Cutting

Catalog #	Size, Bite Size
NS-326-01	20 cm (8), 1 mm
NS-326-02	20 cm (8), 2 mm
NS-326-03	20 cm (8), 3 mm
NS-326-04	20 cm (8), 4 mm
NS-326-05	20 cm (8), 5 mm



**Ferris-Smith Kerrison Rongeur**

Detachable Model, 40° Down Cutting

Catalog #	Size, Bite Size
NS-327-01	20 cm (8), 1 mm
NS-327-02	20 cm (8), 2 mm
NS-327-03	20 cm (8), 3 mm
NS-327-04	20 cm (8), 4 mm
NS-327-05	20 cm (8), 5 mm



**Ferris-Smith Kerrison Rongeur**

Up Cutting

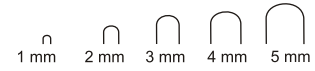

Catalog #	Size, Bite Size
NS-330-01	18 cm (7), 1 mm
NS-330-02	18 cm (7), 2 mm
NS-330-03	18 cm (7), 3 mm
NS-330-04	18 cm (7), 4 mm
NS-330-05	18 cm (7), 5 mm



**Ferris-Smith Kerrison Rongeur**

Down Cutting

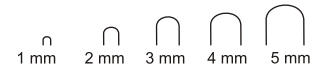

Catalog #	Size, Bite Size
NS-331-01	18 cm (7), 1 mm
NS-331-02	18 cm (7), 2 mm
NS-331-03	18 cm (7), 3 mm
NS-331-04	18 cm (7), 4 mm
NS-331-05	18 cm (7), 5 mm



**Ferris-Smith Kerrison Rongeur**

40° Forward Up Cutting



Catalog #	Size, Bite Size
NS-332-01	18 cm (7), 1 mm
NS-332-02	18 cm (7), 2 mm
NS-332-03	18 cm (7), 3 mm
NS-332-04	18 cm (7), 4 mm
NS-332-05	18 cm (7), 5 mm



Pinzas cortantes para laminectomía  
Pincès emporte-pièces à laminectomie  
Pinze taglianti per laminectomia

**Ferris-Smith Kerrison Rongeur**

40° Forward Down Cutting



Catalog #	Size, Bite Size
NS-333-01	18 cm (7), 1 mm
NS-333-02	18 cm (7), 2 mm
NS-333-03	18 cm (7), 3 mm
NS-333-04	18 cm (7), 4 mm
NS-333-05	18 cm (7), 5 mm

**Ferris-Smith Kerrison Rongeur**

Up Cutting

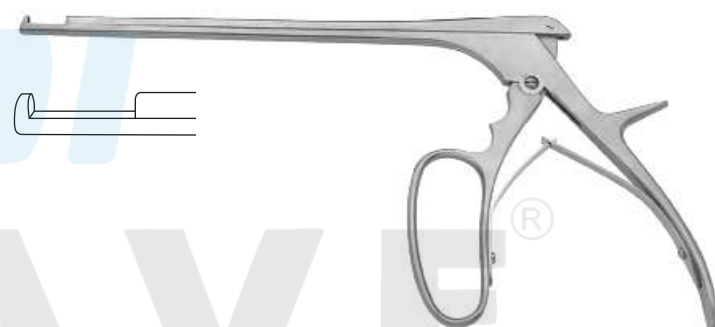

Catalog #	Size, Bite Size
NS-334-01	20 cm (8), 1 mm
NS-334-02	20 cm (8), 2 mm
NS-334-03	20 cm (8), 3 mm
NS-334-04	20 cm (8), 4 mm
NS-334-05	20 cm (8), 5 mm

**Ferris-Smith Kerrison Rongeur**

Down Cutting



Catalog #	Size, Bite Size
NS-335-01	20 cm (8), 1 mm
NS-335-02	20 cm (8), 2 mm
NS-335-03	20 cm (8), 3 mm
NS-335-04	20 cm (8), 4 mm
NS-335-05	20 cm (8), 5 mm



**Ferris-Smith Kerrison Rongeur**

40° Forward Up Cutting

1 mm 2 mm 3 mm 4 mm 5 mm

Catalog #	Size, Bite Size
NS-336-01	20 cm (8), 1 mm
NS-336-02	20 cm (8), 2 mm
NS-336-03	20 cm (8), 3 mm
NS-336-04	20 cm (8), 4 mm
NS-336-05	20 cm (8), 5 mm

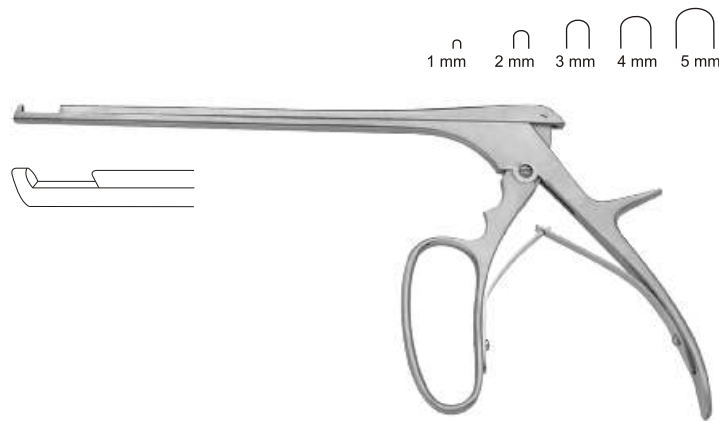

**Ferris-Smith Kerrison Rongeur**

40° Forward Down Cutting

1 mm 2 mm 3 mm 4 mm 5 mm

Catalog #	Size, Bite Size
NS-337-01	20 cm (8), 1 mm
NS-337-02	20 cm (8), 2 mm
NS-337-03	20 cm (8), 3 mm
NS-337-04	20 cm (8), 4 mm
NS-337-05	20 cm (8), 5 mm

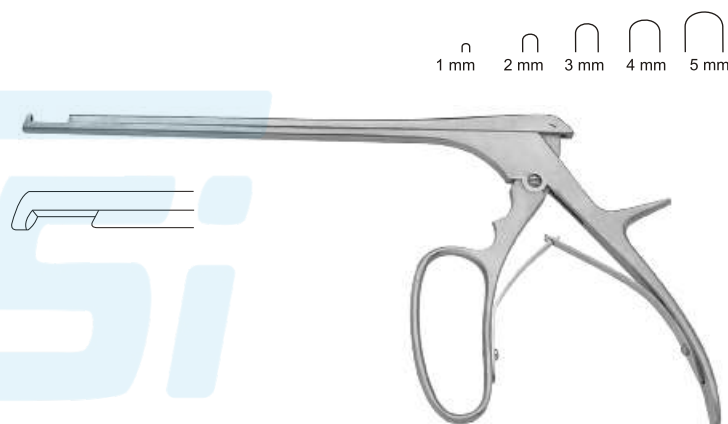

**Cushing Leminectomy Rongeur**

Catalog #	Size, Bite Size, Profile
NS-400-01	13 cm (5), 2 x 10 mm, Straight
NS-400-02	13 cm (5), 2 x 10 mm, Up
NS-400-03	13 cm (5), 2 x 10 mm, Down

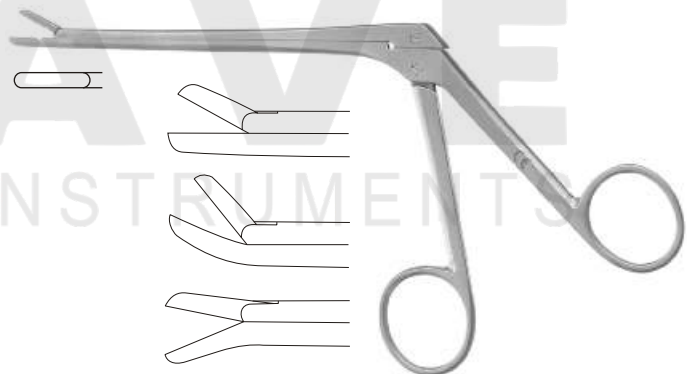

**Cushing Leminectomy Rongeur**

Catalog #	Size, Bite Size, Profile
NS-401-01	15 cm (6), 2 x 10 mm, Straight
NS-401-02	15 cm (6), 2 x 10 mm, Up
NS-401-03	15 cm (6), 2 x 10 mm, Down

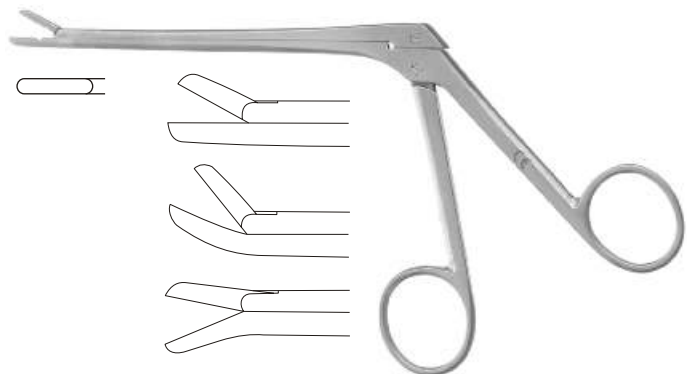

Pinzas cortantes para laminectomía  
Pincès emporte-pièces à laminectomie  
Pinze taglianti per laminectomia

**Cushing Leminectomy Rongeur**

Catalog #	Size, Bite Size, Profile
NS-402-01	18 cm (7), 2 x 10 mm, Straight
NS-402-02	18 cm (7), 2 x 10 mm, Up
NS-402-03	18 cm (7), 2 x 10 mm, Down

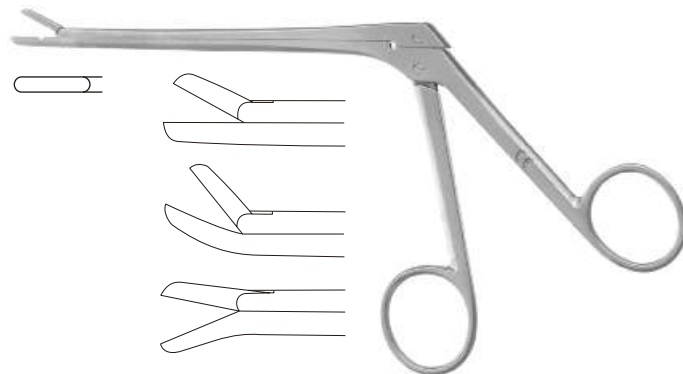

**Cushing Leminectomy Rongeur**

Catalog #	Size, Bite Size, Profile
NS-403-01	20 cm (8), 2 x 10 mm, Straight
NS-403-02	20 cm (8), 2 x 10 mm, Up
NS-403-03	20 cm (8), 2 x 10 mm, Down

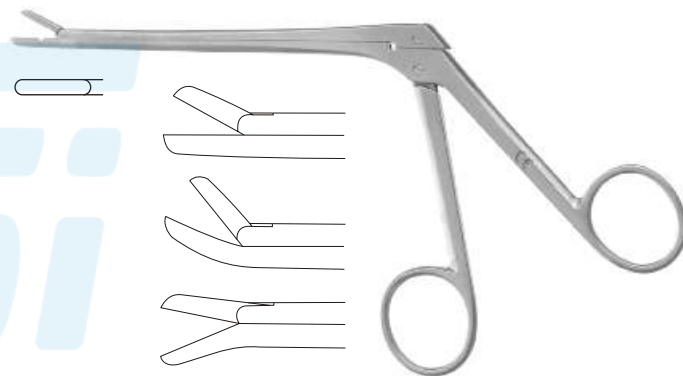

**Love-Gruenwald Leminectomy Rongeur**

Catalog #	Size, Bite Size, Profile
NS-404-01	13 cm (5), 3 x 10 mm, Straight
NS-404-02	13 cm (5), 3 x 10 mm, Up
NS-404-03	13 cm (5), 3 x 10 mm, Down

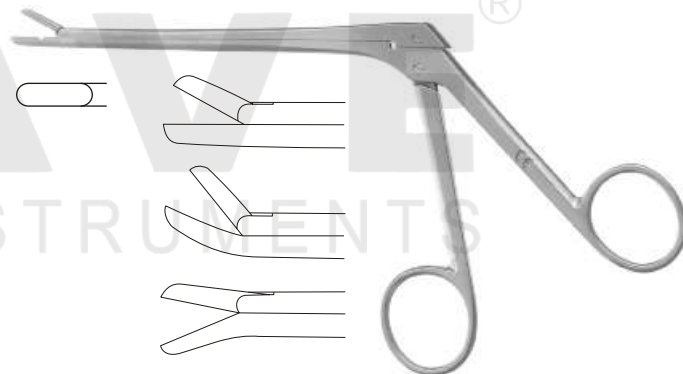

**Love-Gruenwald Leminectomy Rongeur**

Catalog #	Size, Bite Size, Profile
NS-405-01	15 cm (6), 3 x 10 mm, Straight
NS-405-02	15 cm (6), 3 x 10 mm, up
NS-405-03	15 cm (6), 3 x 10 mm, Down

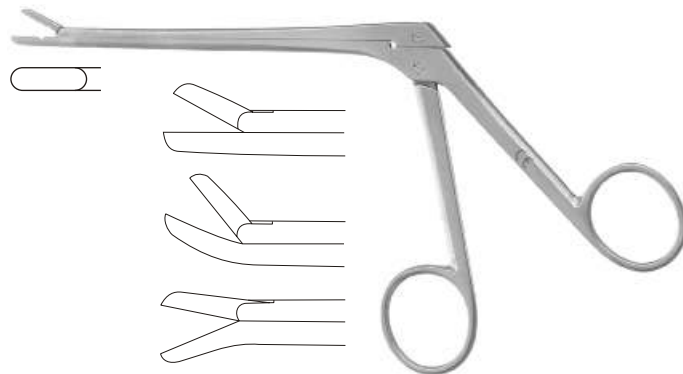



**Love-Gruenwald Leminectomy Rongeur**

Catalog #	Size, Bite Size, Profile
NS-406-01	18 cm (7), 3 x 10 mm, Straight
NS-406-02	18 cm (7), 3 x 10 mm, Up
NS-406-03	18 cm (7), 3 x 10 mm, Down

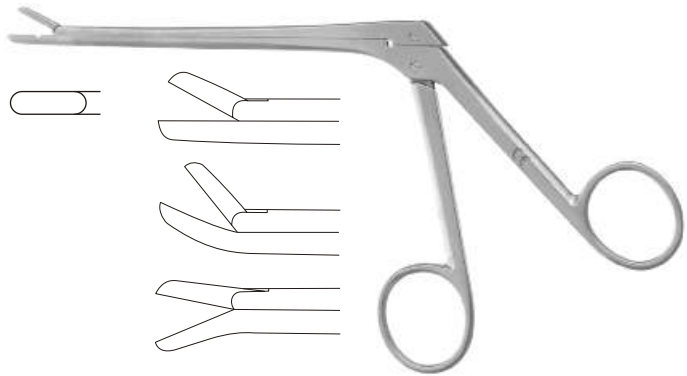

**Love-Gruenwald Leminectomy Rongeur**

Catalog #	Size, Bite Size, Profile
NS-407-01	20 cm (8), 3 x 10 mm, Straight
NS-407-02	20 cm (8), 3 x 10 mm, Up
NS-407-03	20 cm (8), 3 x 10 mm, Down

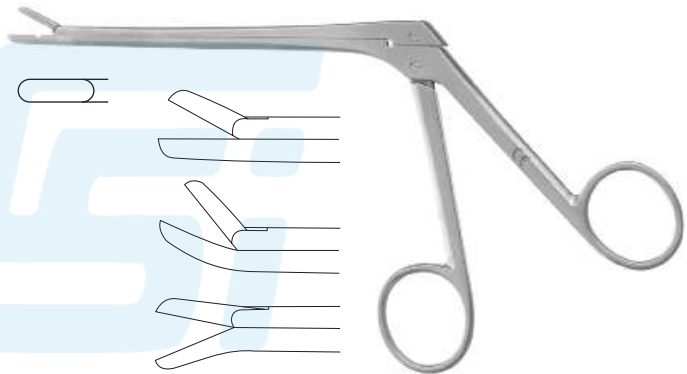

**Spurling Leminectomy Rongeur**

Catalog #	Size, Bite Size, Profile
NS-408-01	13 cm (5), 4 x 10 mm, Straight
NS-408-02	13 cm (5), 4 x 10 mm, Up
NS-408-03	13 cm (5), 4 x 10 mm, Down

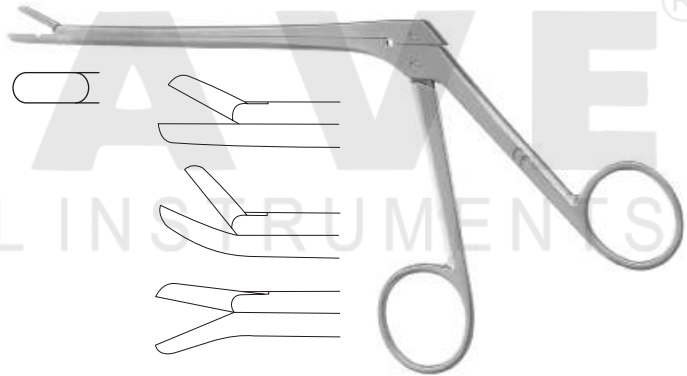

**Spurling Leminectomy Rongeur**

Catalog #	Size, Bite Size, Profile
NS-409-01	15 cm (6), 4 x 10 mm, Straight
NS-409-02	15 cm (6), 4 x 10 mm, Up
NS-409-03	15 cm (6), 4 x 10 mm, Down

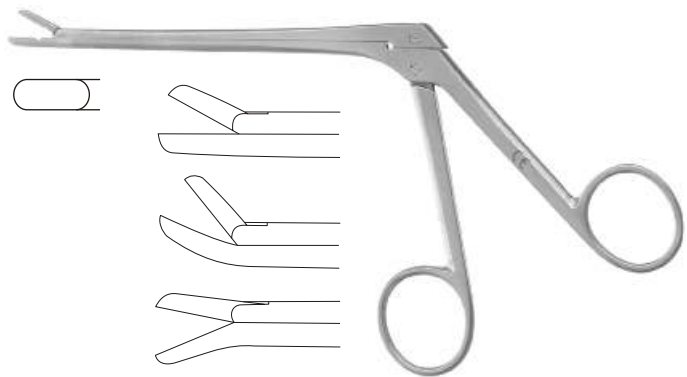

Pinzas cortantes para laminectomía  
Pincès emporte-pièces à laminectomie  
Pinze taglianti per laminectomia

**Spurling Leminectomy Rongeur**

Catalog #	Size, Bite Size, Profile
NS-410-01	18 cm (7), 4 x 10 mm, Straight
NS-410-02	18 cm (7), 4 x 10 mm, up
NS-410-03	18 cm (7), 4 x 10 mm, Down

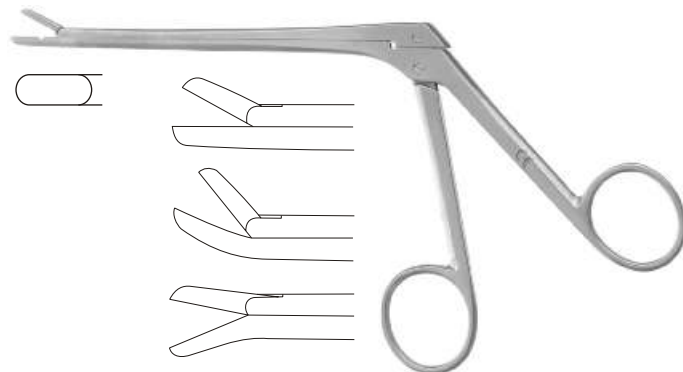

**Spurling Leminectomy Rongeur**

Catalog #	Size, Bite Size, Profile
NS-411-01	20 cm (8), 4 x 10 mm, Straight
NS-411-02	20 cm (8), 4 x 10 mm, Up
NS-411-03	20 cm (8), 4 x 10 mm, Down



**Ferris-Smith Leminectomy Rongeur  
Straight**

Catalog #	Size, Bite Size, Profile
NS-430-01	15.5 cm (6), 2 mm, Straight
NS-430-02	15.5 cm (6), 2 mm, Up
NS-430-03	15.5 cm (6), 2 mm, Down

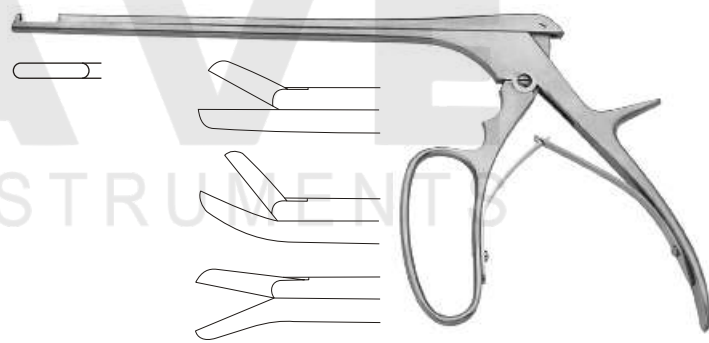

**Ferris-Smith Leminectomy Rongeur**

Catalog #	Size, Bite Size, Profile
NS-431-01	15.5 cm (6), 3 mm, Straight
NS-431-02	15.5 cm (6), 3 mm, Up
NS-431-03	15.5 cm (6), 3 mm, Down

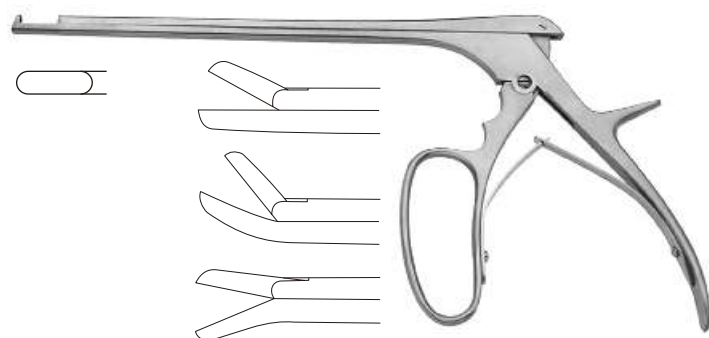

**Ferris-Smith Leminectomy Rongeur**

Catalog #	Size, Bite Size, Profile
NS-432-01	15.5 cm (6), 4 mm, Straight
NS-432-02	15.5 cm (6), 4 mm, Up
NS-432-03	15.5 cm (6), 4 mm, Down

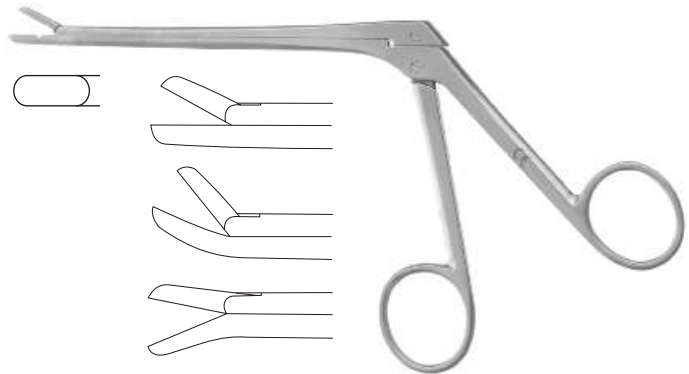

**Ferris-Smith Leminectomy Rongeur**

Catalog #	Size, Bite Size, Profile
NS-433-01	15.5 cm (6), 5 mm, Straight
NS-433-02	15.5 cm (6), 5 mm, Up
NS-433-03	15.5 cm (6), 5 mm, Down

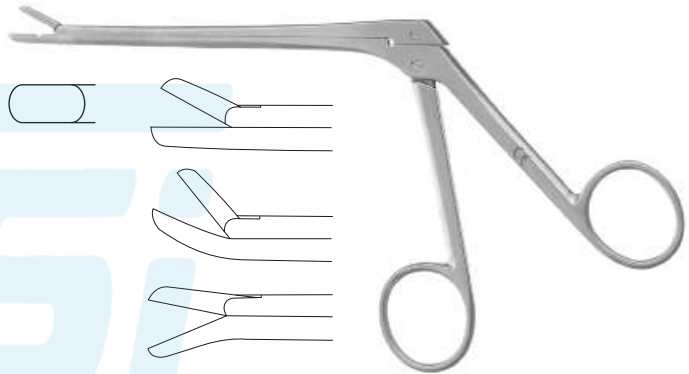

**Leminectomy Rongeur**  
Fenestrated and Serrated Jaws

Catalog #	Size, Bite Size, Profile
NS-440-01	15.5 cm (6), 2 x 12 mm, Straight
NS-440-02	15.5 cm (6), 2 x 12 mm, Up
NS-440-03	15.5 cm (6), 2 x 12 mm, Down

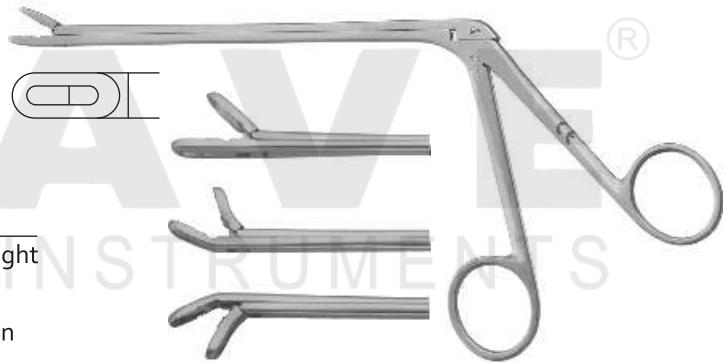

**Leminectomy Rongeur**  
Fenestrated and Serrated Jaws

Catalog #	Size, Bite Size, Profile
NS-441-01	15.5 cm (6), 3 x 12 mm, Straight
NS-441-02	15.5 cm (6), 3 x 12 mm, Up
NS-441-03	15.5 cm (6), 3 x 12 mm, Down



Pinzas cortantes para laminectomía  
Pincès emporte-pièces à laminectomie  
Pinze taglianti per laminectomia

**Laminectomy Rongeur**

Straight, Fenestrated and Serrated Jaws

Catalog #	Size, Bite Size, Profile
NS-442-01	15.5 cm (6), 4 x 14 mm, Straight
NS-442-02	15.5 cm (6), 4 x 14 mm, Up
NS-442-03	15.5 cm (6), 4 x 14 mm, Down



**Laminectomy Rongeur**

Fenestrated and Serrated Jaws

Catalog #	Size, Bite Size, Profile
NS-443-01	15.5 cm (6), 5 x 14 mm, Straight
NS-443-02	15.5 cm (6), 5 x 14 mm, Up
NS-443-03	15.5 cm (6), 5 x 14 mm, Down



**Laminectomy Rongeur**

Fenestrated and Serrated Jaws

Catalog #	Size, Bite Size, Profile
NS-444-01	15.5 cm (6), 6 x 14 mm, Straight
NS-444-02	15.5 cm (6), 6 x 14 mm, Up
NS-444-03	15.5 cm (6), 6 x 14 mm, Down

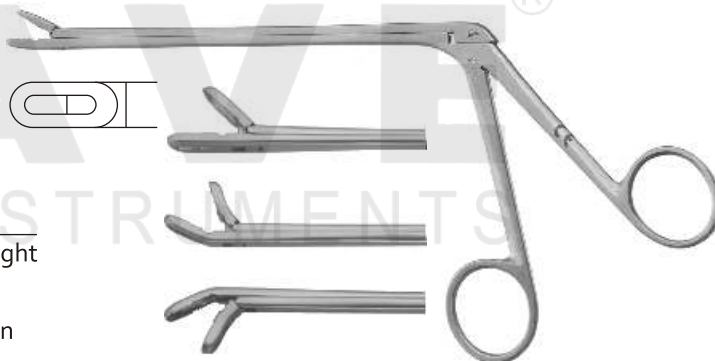

**Schlesinger Laminectomy Rongeur**

Serrated Jaws

Catalog #	Size, Bite Size
NS-451-02	13 cm (5), 2 x 10 mm
NS-451-03	13 cm (5), 3 x 10 mm
NS-451-04	13 cm (5), 4 x 10 mm





**Yasargil Tumor Grasping Forcep**



Catalog #	Size, Bite Size
NS-461-35	20 cm (8), Ø 3.5 mm

**Oldberg Tumor Grasping Forcep**



Catalog #	Size, Bite Size
NS-463-60	18 cm (7), Ø 6.5 mm

**Jacobson Micro Knife**

Straight



Catalog #	Size
NS-550-18	18.5 cm (7 ¼)

**Koos Micro Knife**

Bayonet Shaped



Catalog #	Size, Bite Size
NS-555-01	18.5 cm (7 ¼)
NS-555-02	18.5 cm (7 ¼)
NS-555-03	18.5 cm (7 ¼)
NS-555-04	18.5 cm (7 ¼)

**Koos Micro Knife**

Bayonet Shaped



Catalog #	Size
NS-557-01	18.5 cm (7 ¼)
NS-557-02	18.5 cm (7 ¼)



**Yasargil Micro Knife**

Bayonet Shaped

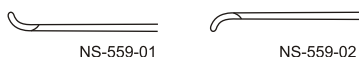

Catalog #	Size
NS-559-01	18.5 cm (7 1/4)
NS-559-02	18.5 cm (7 1/4)

**Yasargil Micro Respiratory**

Straight

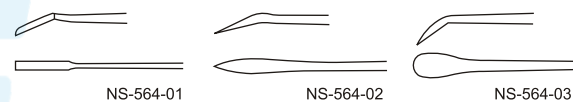

Catalog #	Size
NS-564-01	18.5 cm (7 1/4)
NS-564-02	18.5 cm (7 1/4)
NS-564-03	18.5 cm (7 1/4)
NS-564-04	18.5 cm (7 1/4)
NS-564-05	18.5 cm (7 1/4)

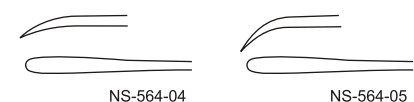

**Yasargil Micro Respiratory**

Bayonet Shaped

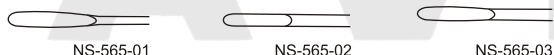

Catalog #	Size
NS-565-01	18.5 cm (7 1/4)
NS-565-02	18.5 cm (7 1/4)
NS-565-03	18.5 cm (7 1/4)



**Yasargil Micro Curette**

Bayonet Shaped

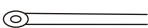

Catalog #	Size
NS-567-18	18.5 cm (7 1/4)

### Micro Nerve & Vessel Hook



Catalog #	Size, Tip Length
NS-571-01	18.5 cm (7 1/4), 3.0 mm
NS-571-02	18.5 cm (7 1/4), 5.0 mm

### Krayenbuhl Micro Nerve & Vessel Hook

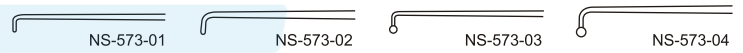

Catalog #	Size, Profile
NS-573-01	18.5 cm (7 1/4), Fig . 1
NS-573-02	18.5 cm (7 1/4), Fig . 2
NS-573-03	18.5 cm (7 1/4), Fig . 3
NS-573-04	18.5 cm (7 1/4), Fig . 4



### Yasargil Ligature Guide

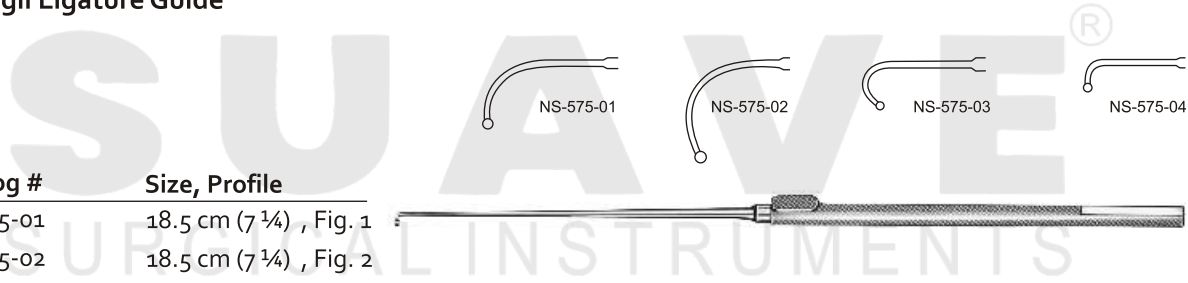

Catalog #	Size, Profile
NS-575-01	18.5 cm (7 1/4) , Fig. 1
NS-575-02	18.5 cm (7 1/4) , Fig. 2
NS-575-03	18.5 cm (7 1/4) , Fig. 3
NS-575-04	18.5 cm (7 1/4) , Fig. 4



### Micro Vessel Dilator



Catalog #	Size, Diameter , Profile
NS-577-01	12.5 cm (5) , Ø 0.5 mm, Fig. 1
NS-577-02	12.5 cm (5) , Ø 1.0 mm, Fig. 2
NS-577-3	12.5 cm (5) , Ø 1.5 mm, Fig. 3

**Jacobson Micro Vessel Probe**

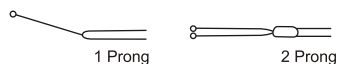

Catalog #	Size, Profile
NS-579-01	18.5 cm (7 1/4), 1 Prong
NS-579-02	18.5 cm (7 1/4), 2 Prong

**Jacobson Micro Suture Pusher**



Catalog #	Size
NS-579-03	18.5 cm (7 1/4)

**Rhoton Micro Dissector**

Set of 15 Ref: NS-591-01 up to NS-591-15



Catalog #	Size
NS-590-00	N/A

**Rhoton Micro Dissector**

Round Shaped

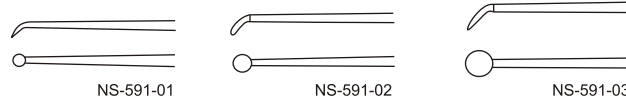

Catalog #	Size, Diameter
NS-591-01	18.5 cm (7 1/4), Ø 1.0 mm
NS-591-02	18.5 cm (7 1/4), Ø 2.0 mm
NS-591-03	18.5 cm (7 1/4), Ø 3.0 mm

**Rhoton Micro Dissector**

Spatula Shaped

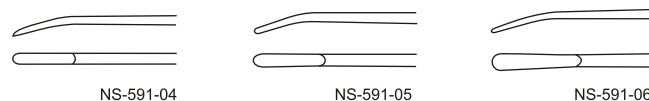

Catalog #	Size, Tip Size
NS-591-04	18.5 cm (7 1/4), 1.0 mm
NS-591-05	18.5 cm (7 1/4), 1.5 mm

**Rhoton Micro Elevator**

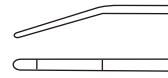

NS-591-07



NS-591-08



Catalog #	Size, Tip Size
NS-591-07	18.5 cm (7 1/4), 1.2 mm
NS-591-08	18.5 cm (7 1/4), 2.8 mm

**Rhoton Micro Needle**

Semi, Sharp



Catalog #	Size
NS-591-09	18.5 cm (7 1/4)

**Rhoton Micro Hook**

Angled 90°, Blunt



Catalog #	Size, Tip Size
NS-591-10	18.5 cm (7 1/4), 2 m m

**Rhoton Micro Hook**

Angled 90°, Semi Sharp



Catalog #	Size, Tip Size
NS-591-11	18.5 cm (7 1/4), 2 m m

**Rhoton Micro Hook**

Angled 45°, Semi Sharp



Catalog #	Size, Tip Size
NS-591-12	18.5 cm (7 1/4), 3 m m



**Rhoton Micro Hook**

Angled 90°



Catalog #	Size
NS-591-13	18.5 cm (7 1/4)

**Rhoton Micro Curette**

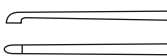

Catalog #	Size, Tip Size
NS-591-14	18.5 cm (7 1/4), 1.0 x 2.0 mm

**Rhoton Micro Curette**

Angled 45°

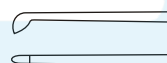

Catalog #	Size, Tip Size
NS-591-15	18.5 cm (7 1/4), 1.0 x 2.0 mm

**Yasargil Micro Elevator**

Bayonet Shaped

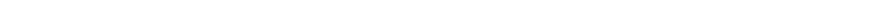

Catalog #	Size
NS-607-24	24 cm (9 1/2)

**Yasargil Micro Elevator**

Bayonet Shaped

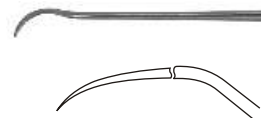

Catalog #	Size
NS-611-24	24 cm (9 1/2)



**Yasargil Micro Raspatory**

Bayonet Shaped



Catalog #	Size
NS-613-24	24 cm (9 1/2)

**Yasargil Micro Dissector**

Bayonet Shaped

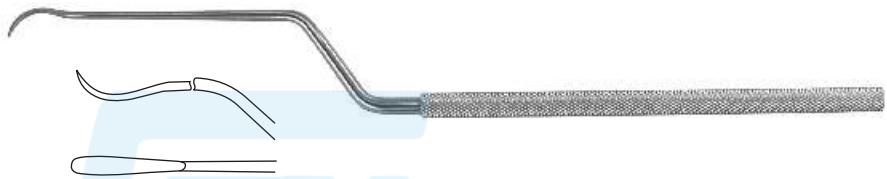

Catalog #	Size
NS-615-01	24 cm (9 1/2)
NS-615-02	24 cm (9 1/2)

**Yasargil Micro Needle**

Bayonet Shaped, Semi Sharp



Catalog #	Size
NS-618-24	24 cm (9 1/2)

**Yasargil Micro Curette**

Straight



Catalog #	Size
NS-631-01	24 cm (9 1/2)

**Yasargil Micro Curette**

Angled



Catalog #	Size
NS-633-01	24 cm (9 1/2)



**Yasargil Micro Curette**

Bayonet Shaped



Catalog #	Size
NS-635-01	24 cm (9 1/2)

**Hardy Micro Sickle Dissector**

Bayonet Shaped, Blunt



Catalog #	Size
NS-651-01	24 cm (9 1/2)
NS-651-02	24 cm (9 1/2)

**Hardy Micro Sickle Dissector**

Bayonet Shaped, Sharp



Catalog #	Size
NS-651-03	24 cm (9 1/2)
NS-651-04	24 cm (9 1/2)

**Hardy Implant Fork**

Bayonet Shaped



Catalog #	Size
NS-655-24	24 cm (9 1/2)

**Hardy-Fahlbusch Micro Dissector**

Bayonet Shaped Sharp



Catalog #	Size
NS-659-01	24 cm (9 1/2)
NS-659-02	24 cm (9 1/2)

**Casper Micro Dissector**

Set of 6 Ref: NS-671-10 up to NS-675-10



Catalog #	Size
NS-670-00	N/A

**Casper Micro Dissector**

Straight



Catalog #	Size, Tip Size
NS-671-10	24 cm (9 1/2) , 1.0 mm
NS-671-45	24 cm (9 1/2) , 4.5 mm

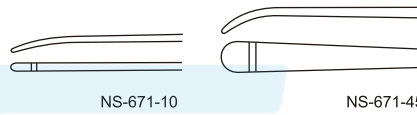

**Casper Micro Dissector**

Bayonet Shaped, Curved Down



Catalog #	Size, Tip Size
NS-673-10	24 cm (9 1/2) , 1.0 mm
NS-673-20	24 cm (9 1/2) , 2.0 mm
NS-673-45	24 cm (9 1/2) , 4.5 mm

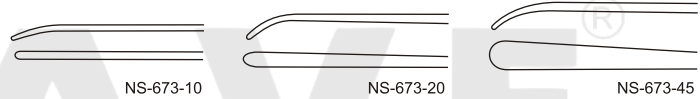

**Casper Micro Dissector**

Bayonet Shaped, Curved Up



Catalog #	Size, Tip Size
NS-675-10	24 cm (9 1/2) , 1.0 mm

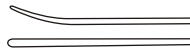

**Micro Dissector**

Straight



Catalog #	Size
NS-679-10	19 cm (7 1/2 )
NS-679-22	21.5 cm (8 1/2)

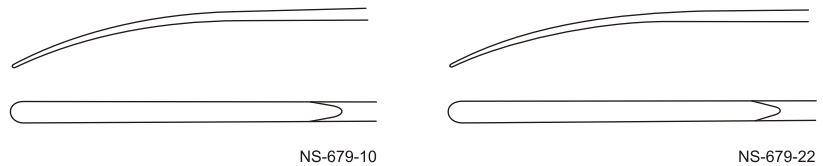

**Ray Micro Curette**

Angled 45°, Horizontal



Catalog #	Size, Diameter
NS-681-01	19 cm (7 1/2 ), Ø 4.0 mm

**Ray Micro Curette**

Angled 45°, Vertical



Catalog #	Size, Diameter
NS-681-02	19 cm (7 1/2 ), Ø 4.0 mm

**Hardy Micro Curette**

Bayonet Shaped

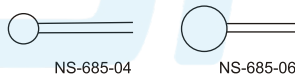

Catalog #	Size, Diameter
NS-685-04	26 cm (10 1/4), Ø 4.0 mm
NS-685-06	26 cm (10 1/4), Ø 6.0 mm



**Nicola Micro Curette**

Bayonet Shaped, Left

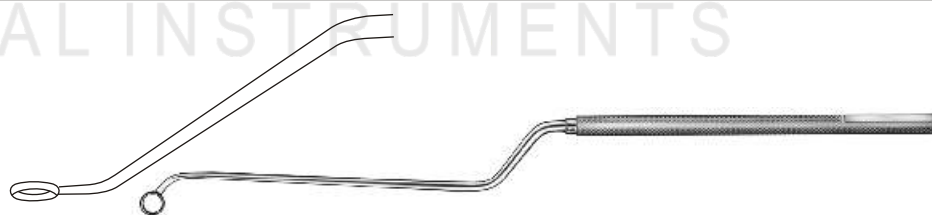

Catalog #	Size, Diameter
NS-689-01	21.5 cm (8 1/2), Ø 6.5 mm

**Nicola Micro Curette**

Bayonet Shaped, Right

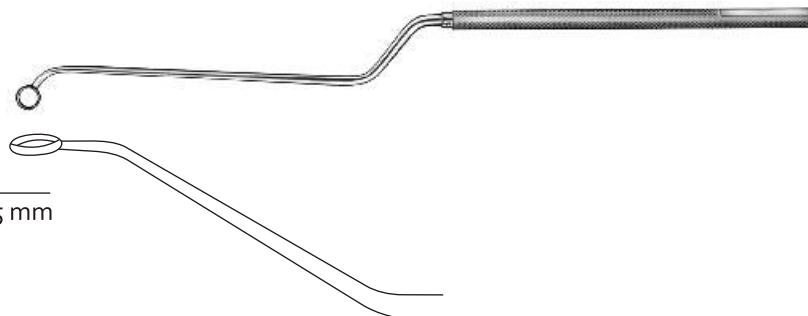

Catalog #	Size, Diameter
NS-689-02	21.5 cm (8 1/2), Ø 6.5 mm

**Nicola Micro Curette**

Bayonet Shaped, Angled Up



Catalog #	Size, Diameter
NS-689-03	21.5 cm (8 ½), Ø 6.5 mm

**Hosobuchi Fork Spatula**

Bayonet Shaped, Rigid

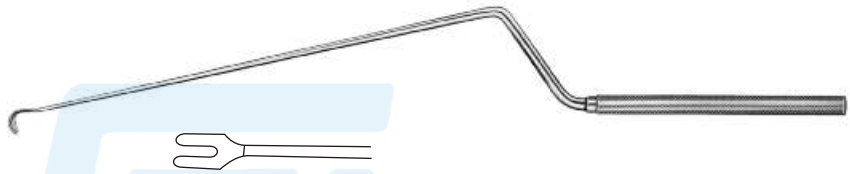

Catalog #	Size
NS-695-26	26 cm (10 ¼)

**Landolt Micro Curette**

Bayonet Shaped, Malleable



Catalog #	Size
NS-697-26	26 cm (10 ¼)

**Landolt Micro Curette**

Bayonet Shaped, Blunt, Malleable

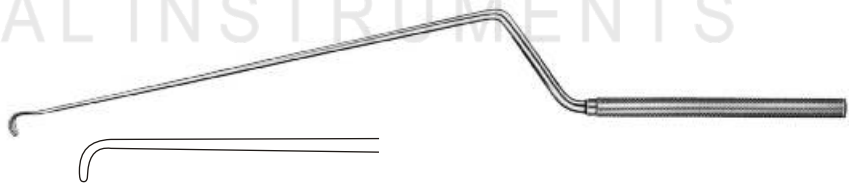

Catalog #	Size
NS-699-26	26 cm (10 ¼)

**Landolt Micro Raspatory**

Bayonet Shaped, Malleable

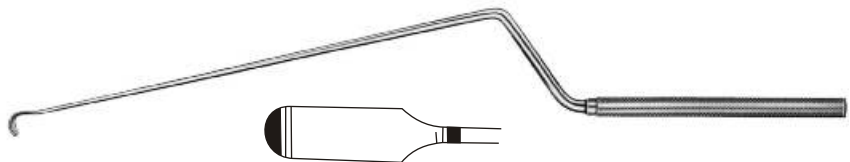

Catalog #	Size
NS-701-26	26 cm (10 ¼)



**Landolt Micro Enucleator**

Bayonet Shaped

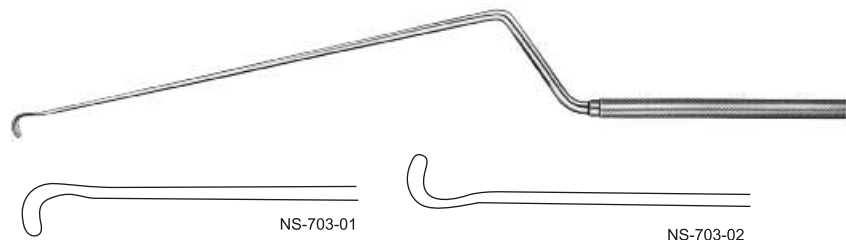

Catalog #	Size
NS-703-01	26 cm (10 ¼)
NS-703-02	26 cm (10 ¼)

**Landolt-Reulen Micro Dissector**

Bayonet Shaped, Rigid

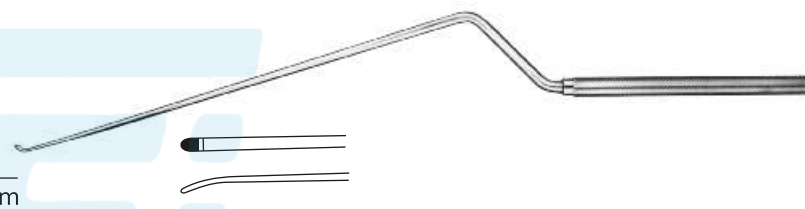

Catalog #	Size, Tip Size
NS-711-26	26 cm (10 ¼), 2.0 mm

**Landolt-Reulen Micro Hook**

Bayonet Shaped, Blunt, Rigid



Catalog #	Size, Tip Size
NS-713-26	26 cm (10 ¼), 1.7 mm

**Landolt-Reulen Micro Curette**

Bayonet Shaped, Rigid

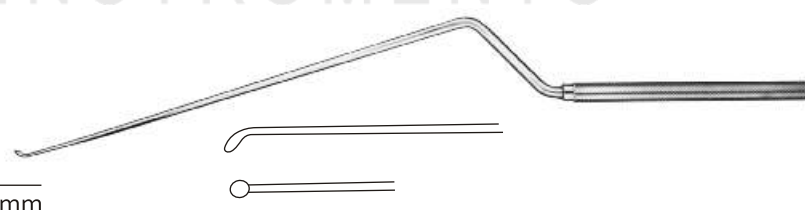

Catalog #	Size, Diameter
NS-715-26	26 cm (10 ¼), Ø 2.5 mm

**Landolt-Reulen Micro Raspatory**

Bayonet Shaped, Rigid

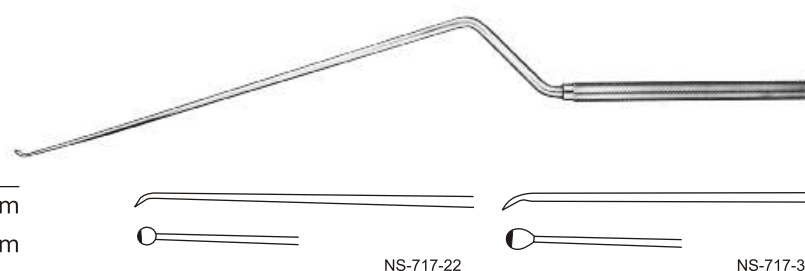

Catalog #	Size, Tip Size
NS-717-22	26 cm (10 ¼), 2.2 mm
NS-717-32	26 cm (10 ¼), 2.2 mm

NS-717-22

NS-717-32

**Fahlbusch Micro Curette**

Bayonet Shaped, Malleable

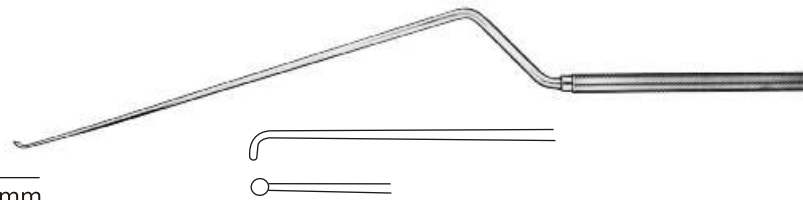

Catalog #	Size, Diameter
NS-719-01	26 cm (10 ¼), Ø 2.5 mm

**Fahlbusch Micro Scoop**

Bayonet Shaped, Malleable

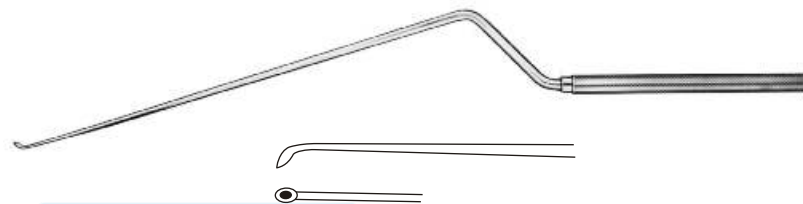

Catalog #	Size
NS-719-02	26 cm (10 ¼)

**Cushing-Landolt Specula**



Catalog #	Size, Blade Size
NS-751-01	N/A, 70 x 15 mm
NS-751-02	N/A, 90 x 15 mm
NS-751-03	N/A, 110 x 15 mm

**Landolt Spccla**

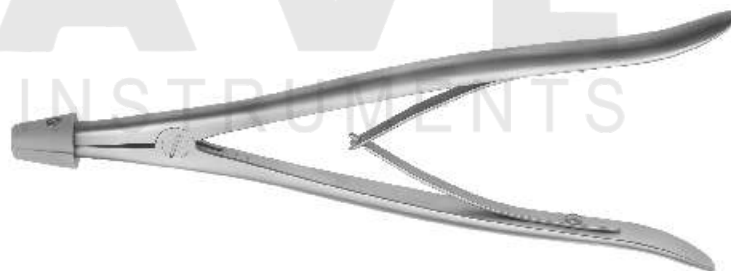

Catalog #	Size
NS-755-21	21.5 cm (8 ½)

**Mirror**



Catalog #	Diameter
NS-790-06	Ø 6.0 mm
NS-790-08	Ø 8.0 mm
NS-790-10	Ø 10.0 mm
NS-790-12	Ø 12.0 mm





Micro Neuro Instrumentos  
Micro Neuro Instruments  
Micro Neuro Strumenti

**Mirror Handle**

Bayonet Shaped



Catalog #	Size
NS-792-00	15 cm (6)



SUAVE<sup>®</sup>  
SURGICAL INSTRUMENTS

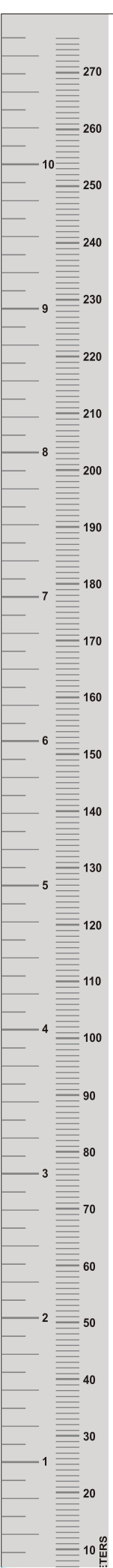



**SUAVE**<sup>®</sup>  
SURGICAL INSTRUMENTS



**RASOOL PUR BHALIAN,  
LALO KAY, SIALKOT - PAKISTAN**

[www.suavesurgical.com](http://www.suavesurgical.com)

[info@suavesurgical.com](mailto:info@suavesurgical.com)

[suavesurgical1988@gmail.com](mailto:suavesurgical1988@gmail.com)

 **+92-346-6623928**

