



**SUAVE**<sup>®</sup>  
SURGICAL INSTRUMENTS



# DENTAL INSTRUMENTS



[www.suavesurgical.com](http://www.suavesurgical.com)  
[info@suavesurgical.com](mailto:info@suavesurgical.com)  
[suavesurgical1988@gmail.com](mailto:suavesurgical1988@gmail.com)

# Extracting Forceps



**SUAVE**<sup>®</sup>  
SURGICAL INSTRUMENTS



**1006**  
Fig 19  
upper wisdoms

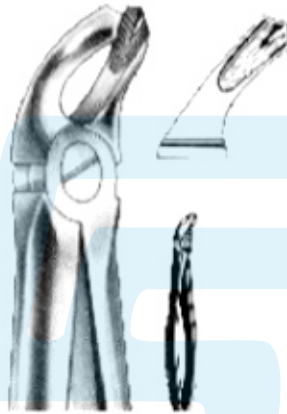

**1007**  
Fig 20  
lower wisdoms

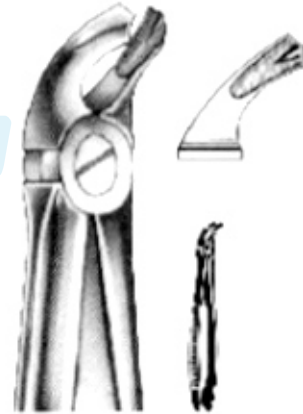

**1008**  
Fig 21  
lower molars



**1009**  
Fig 22  
lower molars

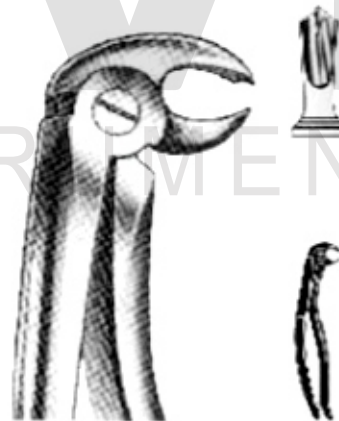

**1010**  
Fig 22 A  
Albrecht  
lower molars



# Extracting Forceps



**SUAVE**<sup>®</sup>  
SURGICAL INSTRUMENTS

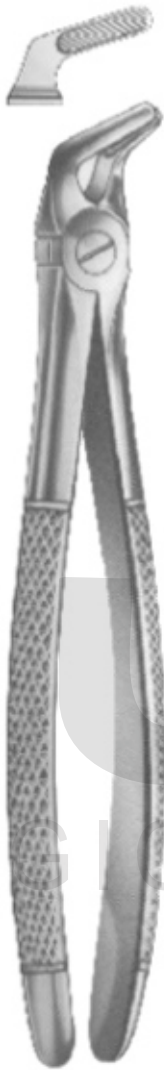

1001  
Fig 8  
lower premolars



1002  
Fig 13  
lower premolars



1003  
Fig 17  
upper molars, right

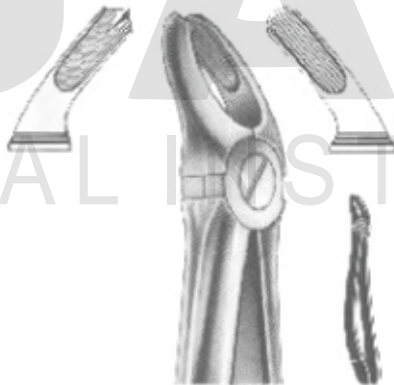

1004  
Fig 18  
upper molars, left

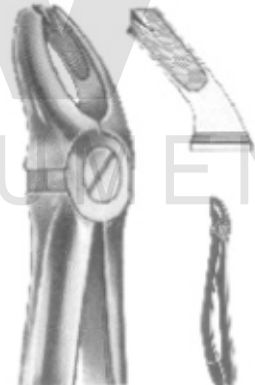

1005  
Fig 18 A  
upper molars



# Extracting Forceps



**SUAVE**<sup>®</sup>  
SURGICAL INSTRUMENTS



1011  
Fig 33 A  
lower roots

1012  
Fig 33 B  
lower roots

1013  
Fig 33 L  
lower roots

1014  
Fig 33 L  
lower roots

1015  
Fig 33 S  
lower roots, for children





# Extracting Forceps



**SUAVE**<sup>®</sup>  
SURGICAL INSTRUMENTS

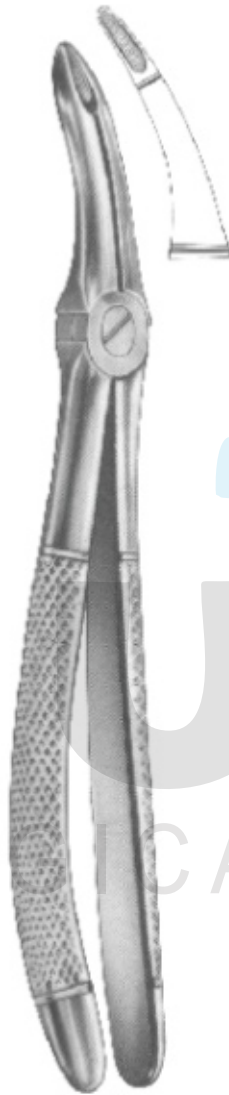

1016  
Fig 44  
upper roots

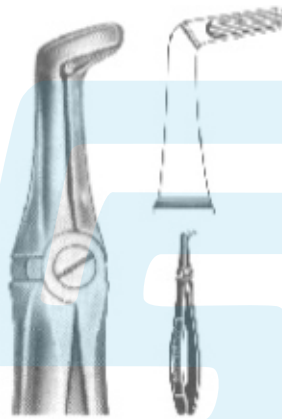

1017  
Fig 45  
lower roots



1018  
Fig 12  
upper roots



1019  
Fig 51 A  
upper roots



1020  
Fig 51 L  
upper roots



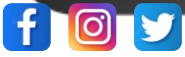

**SUAVE**<sup>®</sup>  
SURGICAL INSTRUMENTS

**Relax'' Extracting Forceps**



**Relax  
1021**  
Fig 51  
upper roots



**Relax  
1022**  
Fig 51 A  
upper roots



**Relax  
1024**  
Fig 67  
upper wisdoms



**Relax  
1023**  
Fig 51 L  
upper roots



**Relax  
1025**  
Fig 67 A  
upper wisdoms



SUAVE<sup>®</sup>  
SURGICAL INSTRUMENTS



**RASOOL PUR BHALIAN, LALO KAY, SIALKOT - PAKISTAN**

[www.suavesurgical.com](http://www.suavesurgical.com)  
[info@suavesurgical.com](mailto:info@suavesurgical.com)  
[suavesurgical1988@gmail.com](mailto:suavesurgical1988@gmail.com)



**SUAVE**<sup>®</sup>  
SURGICAL INSTRUMENTS

**Extracting Forceps FOR Children**



1026  
Fig 37  
Upper incisors



1027  
Fig 39  
Upper molars

WITH SERRATED  
TIPS



1028  
Fig 39 R  
Upper molars, right

WITH SERRATED  
TIPS



1029  
Fig 39 L  
Upper molars, left

WITH SERRATED  
TIPS



1030  
Fig 515  
Upper roots

WITH SERRATED  
TIPS



**RASOOL PUR BHALIAN, LALO KAY, SIALKOT - PAKISTAN**

www.suavesurgical.com  
info@suavesurgical.com  
suavesurgical1988@gmail.com



**SUAVE**<sup>®</sup>  
SURGICAL INSTRUMENTS

**Extracting Forceps FOR Children**

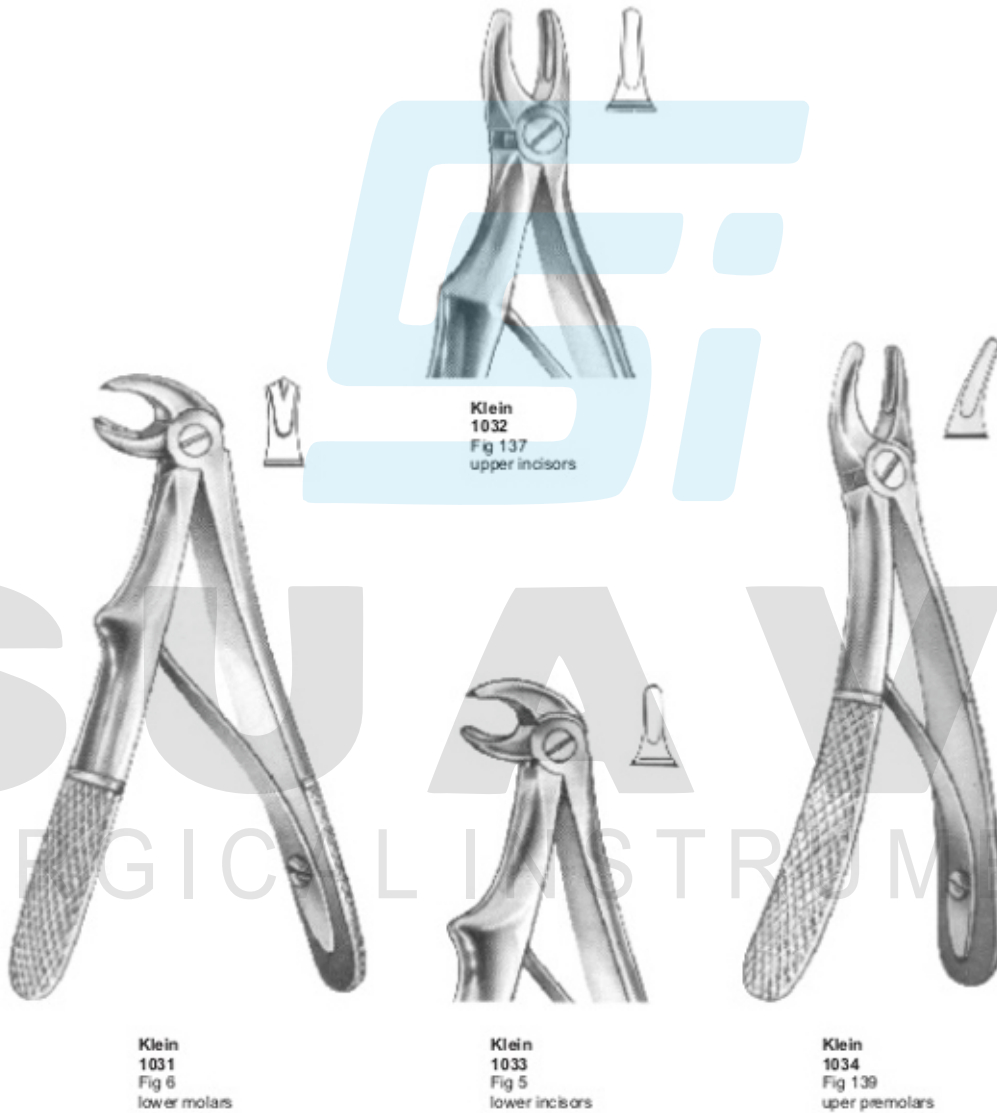

Klein  
1031  
Fig 6  
lower molars

Klein  
1033  
Fig 5  
lower incisors

Klein  
1034  
Fig 139  
upper premolars



**RASOOL PUR BHALIAN, LALO KAY, SIALKOT - PAKISTAN**

www.suavesurgical.com  
info@suavesurgical.com  
suavesurgical1988@gmail.com





**SUAVE**<sup>®</sup>  
SURGICAL INSTRUMENTS

**Extracting Forceps**



**1035**  
Fig 43 A  
Fractured or decayed  
upper teeth



WITH SERRATED  
TIPS



**1036**  
Fig 44  
Upper roots

WITH SERRATED  
TIPS

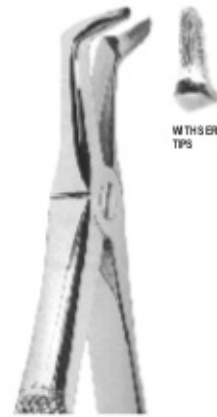

**1037**  
Fig 45  
Lower roots

WITH SERRATED  
TIPS



**1038**  
Fig 46  
Lower roots

WITH SERRATED  
TIPS



**1039**  
Fig 46 L  
Lower roots

WITH SERRATED  
TIPS





**SUAVE**<sup>®</sup>  
SURGICAL INSTRUMENTS

**Extracting Forceps**



1050  
Fig 59  
Lower roots



WITH SERRATED  
TIPS



1051  
Fig 59 L  
Lower incisor  
roots



WITH SERRATED  
TIPS



1052  
Fig 60  
Lower roots



WITH SERRATED  
TIPS



1053  
Fig 65 L  
Upper molars, left



WITH SERRATED  
TIPS



1054  
Fig 65 R  
Upper molars, right



WITH SERRATED  
TIPS



**Extracting Forceps**



**SUAVE**<sup>®</sup>  
SURGICAL INSTRUMENTS



1055  
Fig 66 L  
Upper molars, left



1056  
Fig 66 R  
Upper molars, right



1057  
Fig 67  
Upper third molars



1058  
Fig 67 A  
Upper third molars



1059  
Fig 68  
Lower roots





**SUAVE**<sup>®</sup>  
SURGICAL INSTRUMENTS

**Extracting Forceps**



1060  
Fig 67½ L  
Upper third molars, left



1061  
Fig 67½ R  
Upper third molars, right



1062  
Fig 73  
Lower molars



1063  
Fig 74  
Lower roots



1064  
Fig 74 M  
Lower roots







**SUAVE**<sup>®</sup>  
SURGICAL INSTRUMENTS

**Extracting Forceps**

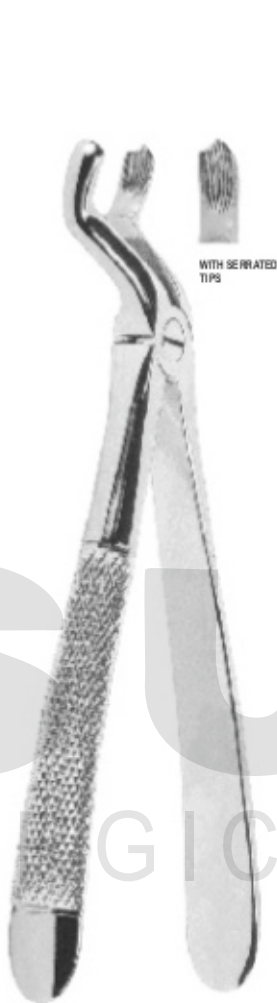

**1060**  
Fig 67 1/2 L  
Upper third molars, left

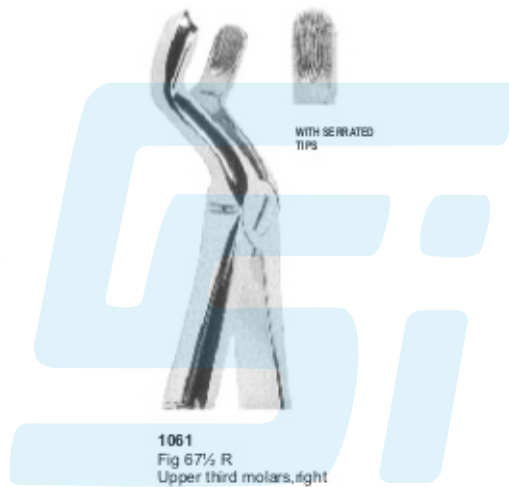

**1061**  
Fig 67 1/2 R  
Upper third molars, right



**1062**  
Fig 73  
Lower molars



**1063**  
Fig 74  
Lower roots



**1064**  
Fig 74 M  
Lower roots



**Extracting Forceps**



**SUAVE**<sup>®</sup>  
SURGICAL INSTRUMENTS



1070  
Fig 86 W  
Lower third molars



1071  
Fig 86 1/2 L  
Lower third molars, left



1072  
Fig 86 1/2 R  
Lower third molars, right



1073  
Fig 86 C  
Lower molars





**SUAVE**<sup>®</sup>  
SURGICAL INSTRUMENTS

**Extracting Forceps**



1074  
Fig 87  
Lower decayed molars  
or broken-down crowns



1075  
Fig 89  
Upper molars, right



1076  
Fig 90  
Upper molars, left



1077  
Fig 99  
Broken-down lower molars

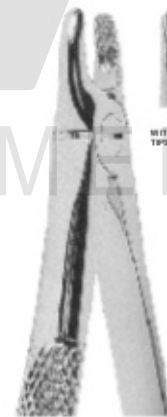

1078  
Fig 107  
Upper canines





**SUAVE**<sup>®</sup>  
SURGICAL INSTRUMENTS

**Extracting Forceps**



1079  
Fig 121  
Upper third molars



1080  
Fig 145  
Lower roots

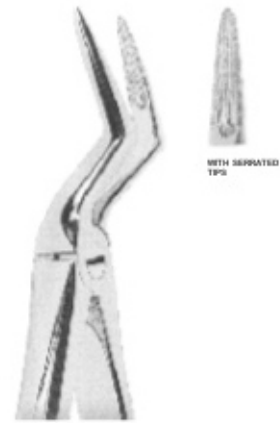

1081  
Fig 151 1/2  
Upper roots



1082  
Fig 166  
Universal extracting forceps for  
upper teeth, in particular molars  
and premolars



1083  
Fig 167  
Universal extracting forceps for  
lower teeth, in particular molars  
and premolars







**SUAVE**<sup>®</sup>  
SURGICAL INSTRUMENTS

**Extracting Forceps**



1084  
Fig 168  
Upper canines



1085  
Fig 169  
Lower canines



1086  
Fig 346  
Lower roots



1087  
Fig 349  
Upper roots



1088  
Fig 359  
Lower roots





**SUAVE**<sup>®</sup>  
SURGICAL INSTRUMENTS

**Extracting Forceps- Mead pattern**



1089  
Fig 1  
Universal extracting forceps for upper incisors and canines

1090  
Fig 2  
Upper molars

1091  
Fig 3  
Lower incisors, premolar and roots

1092  
Fig 4  
Lower molars



**RASOOL PUR BHALIAN, LALO KAY, SIALKOT - PAKISTAN**

www.suavesurgical.com  
info@suavesurgical.com  
suavesurgical1988@gmail.com



**SUAVE**<sup>®</sup>  
SURGICAL INSTRUMENTS

Extracting Forceps With Anatomically Handle



1093  
Fig 1  
Upper incisors  
and canines



1094  
Fig 2  
Upper incisors  
and canines



1095  
Fig 4  
Lower incisors  
and canines

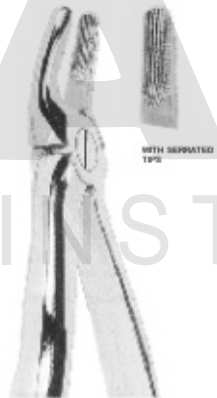

1096  
Fig 7  
Upper premolars



1097  
Fig 13  
Lower premolars



**RASOOL PUR BHALIAN, LALO KAY, SIALKOT - PAKISTAN**

[www.suavesurgical.com](http://www.suavesurgical.com)  
[info@suavesurgical.com](mailto:info@suavesurgical.com)  
[suavesurgical1988@gmail.com](mailto:suavesurgical1988@gmail.com)



**SUAVE**<sup>®</sup>  
SURGICAL INSTRUMENTS

Extracting Forceps With Anatomically Shaped Handle



1098  
Fig 17  
Upper molars, right



1099  
Fig 18  
Upper molars, left

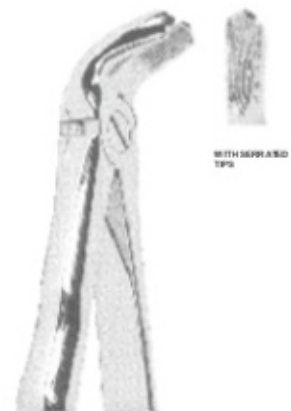

1100  
Fig 21  
Lower molars



1101  
Fig 22  
Lower molars



1102  
Fig 33  
Lower roots







**SUAVE**<sup>®</sup>  
SURGICAL INSTRUMENTS

*Extracting Forceps With Anatomically Shaped Handle*



1103  
Fig 45  
Lower roots



WITH SEPARATED  
TIPS

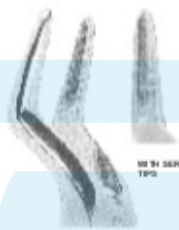

WITH SEPARATED  
TIPS

1104  
Fig 51 A  
Upper roots



WITH SEPARATED  
TIPS

1105  
Fig 67 A  
Upper third  
molars



WITH SEPARATED  
TIPS

1106  
Fig 74  
Lower roots



WITH SEPARATED  
TIPS

1107  
Fig 79  
Lower third  
molars



WITH SEPARATED  
TIPS

1108  
Fig 86 C  
Lower molars



WITH SEPARATED  
TIPS

1109  
Fig 359  
Lower roots



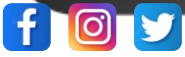

**Extracting Forceps -American Pattern**



**SUAVE**<sup>®</sup>  
SURGICAL INSTRUMENTS



1120  
Fig 18 L  
Upper molars, left



1121  
Fig 18 R  
Upper molars, right



1122  
Fig 23  
Lower molars



1123  
Fig 53 R  
Upper molars, right



1124  
Fig 53 L  
Upper molars, left





**Extracting Forceps -American Pattern**



**SUAVE**<sup>®</sup>  
SURGICAL INSTRUMENTS

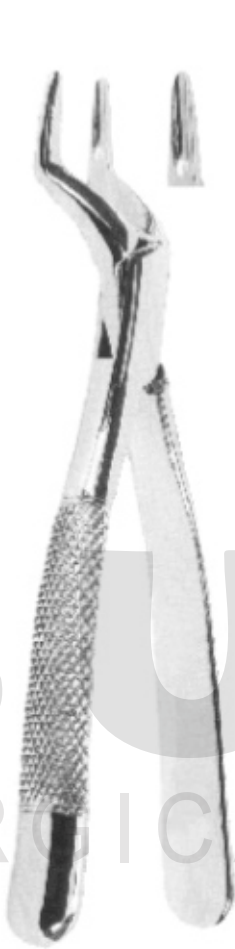

1125  
Fig 65  
Upper incisors and roots



1126  
Fig 69  
Upper and lower roots



1127  
Fig 88 R  
Upper molars, right



1128  
Fig 88 L  
Upper molars, left



1129  
Fig 101  
Deciduous teeth



**Extracting Forceps -American Pattern**



**SUAVE**<sup>®</sup>  
SURGICAL INSTRUMENTS



1130  
Fig 150  
Upper incisors, premolars, roots



1131  
Fig 150 S  
Upper teeth (for children)



1132  
Fig 151  
Upper incisors, premolars, roots



1133  
Fig 151S  
Lower teeth (for children)



1134  
Fig 222  
Lower third molars





**SUAVE**<sup>®</sup>  
SURGICAL INSTRUMENTS

**Extracting Forceps -American Pattern**

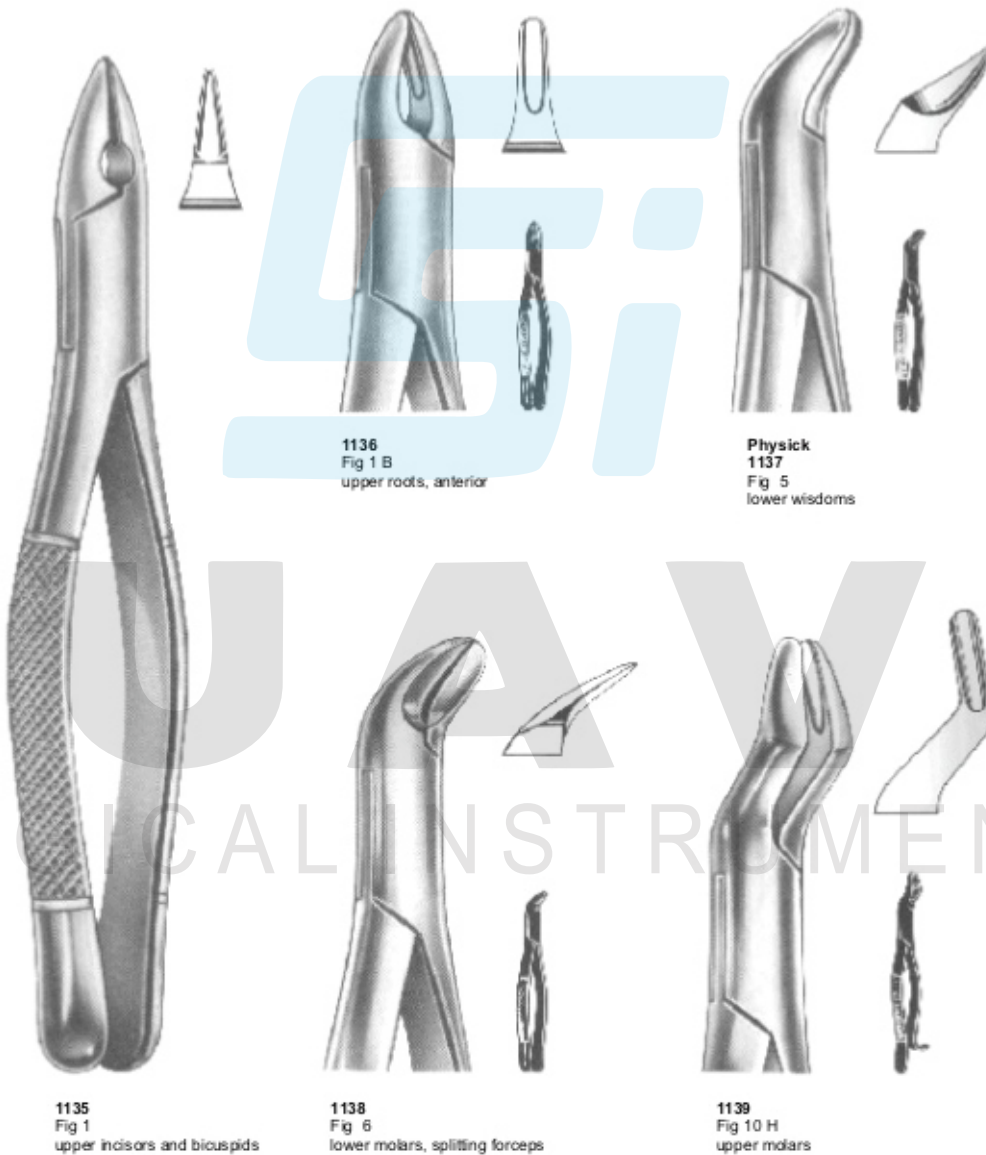





**SUAVE**<sup>®</sup>  
SURGICAL INSTRUMENTS

Extracting Forceps For children -English pattern



1140  
Fig 135  
Lower premolars



1141  
Fig 225  
Lower molars



1142  
Fig 305  
Upper incisors  
and roots

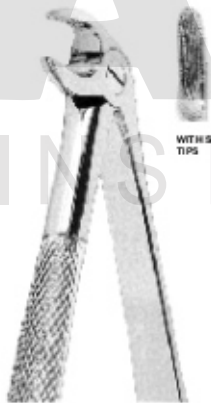

1143  
Fig 33 S  
Lower roots



1144  
Fig 38  
Lower incisors  
and canines



**RASOOL PUR BHALIAN, LALO KAY, SIALKOT - PAKISTAN**

www.suavesurgical.com  
info@suavesurgical.com  
suavesurgical1988@gmail.com

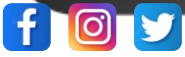

**SUAVE**<sup>®</sup>  
SURGICAL INSTRUMENTS

Extracting Forceps For children -Klein pattern

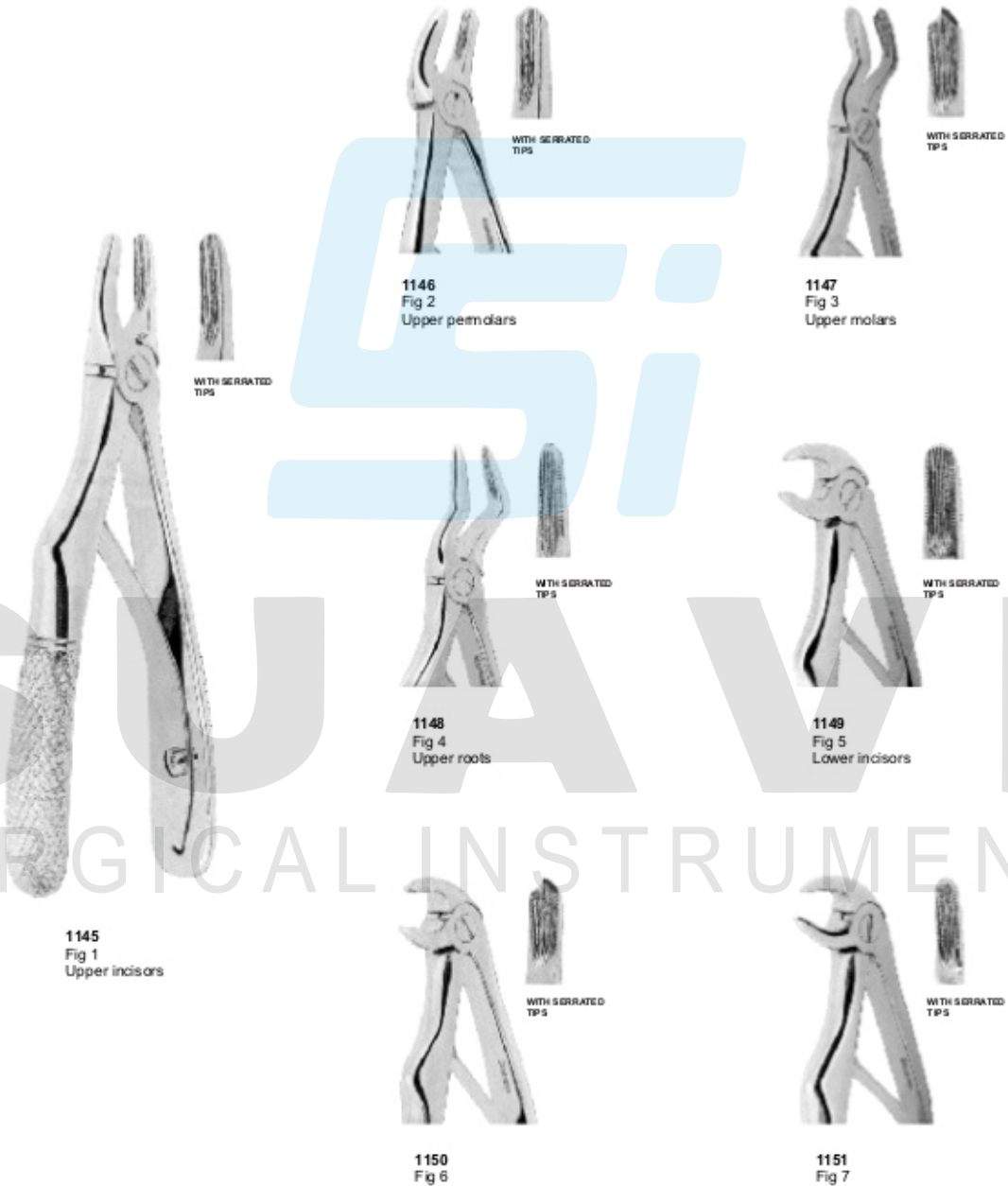

1145  
Fig 1  
Upper incisors

1146  
Fig 2  
Upper premolars

1147  
Fig 3  
Upper molars

1148  
Fig 4  
Upper roots

1149  
Fig 5  
Lower incisors

1150  
Fig 6

1151  
Fig 7



**RASOOL PUR BHALIAN, LALO KAY, SIALKOT - PAKISTAN**

[www.suavesurgical.com](http://www.suavesurgical.com)  
[info@suavesurgical.com](mailto:info@suavesurgical.com)  
[suavesurgical1988@gmail.com](mailto:suavesurgical1988@gmail.com)



**SUAVE**<sup>®</sup>  
SURGICAL INSTRUMENTS

Extracting Forceps- Roots Fragments



SUAVE<sup>®</sup>  
SURGICAL INSTRUMENTS



**RASOOL PUR BHALIAN, LALO KAY, SIALKOT - PAKISTAN**

www.suavesurgical.com  
info@suavesurgical.com  
suavesurgical1988@gmail.com

**Roots Elevators**



**SUAVE**<sup>®</sup>  
SURGICAL INSTRUMENTS

lower jaw, left side

lower jaw, right side

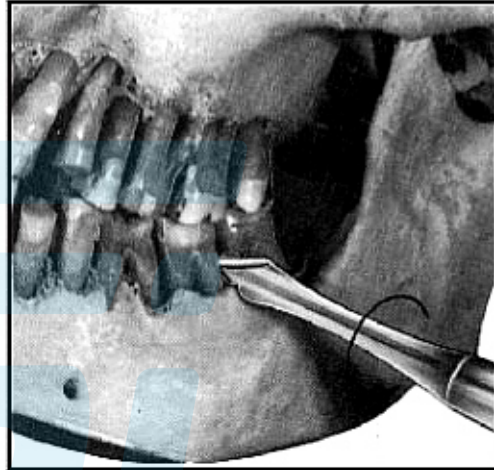

1200



1201

Root elevator, spiral-shaped, for extremely facilitated extraction of the molars in the lower jaw. The slender, conical points allow deep penetration between tooth and gum. Owing to the hook-shaped working parts, slipping of the elevator is avoided.

SUAVE<sup>®</sup>  
SURGICAL INSTRUMENTS



**RASOOL PUR BHALIAN, LALO KAY, SIALKOT - PAKISTAN**

www.suavesurgical.com  
info@suavesurgical.com  
suavesurgical1988@gmail.com



**SUAVE**<sup>®</sup>  
SURGICAL INSTRUMENTS

**Roots Elevators**

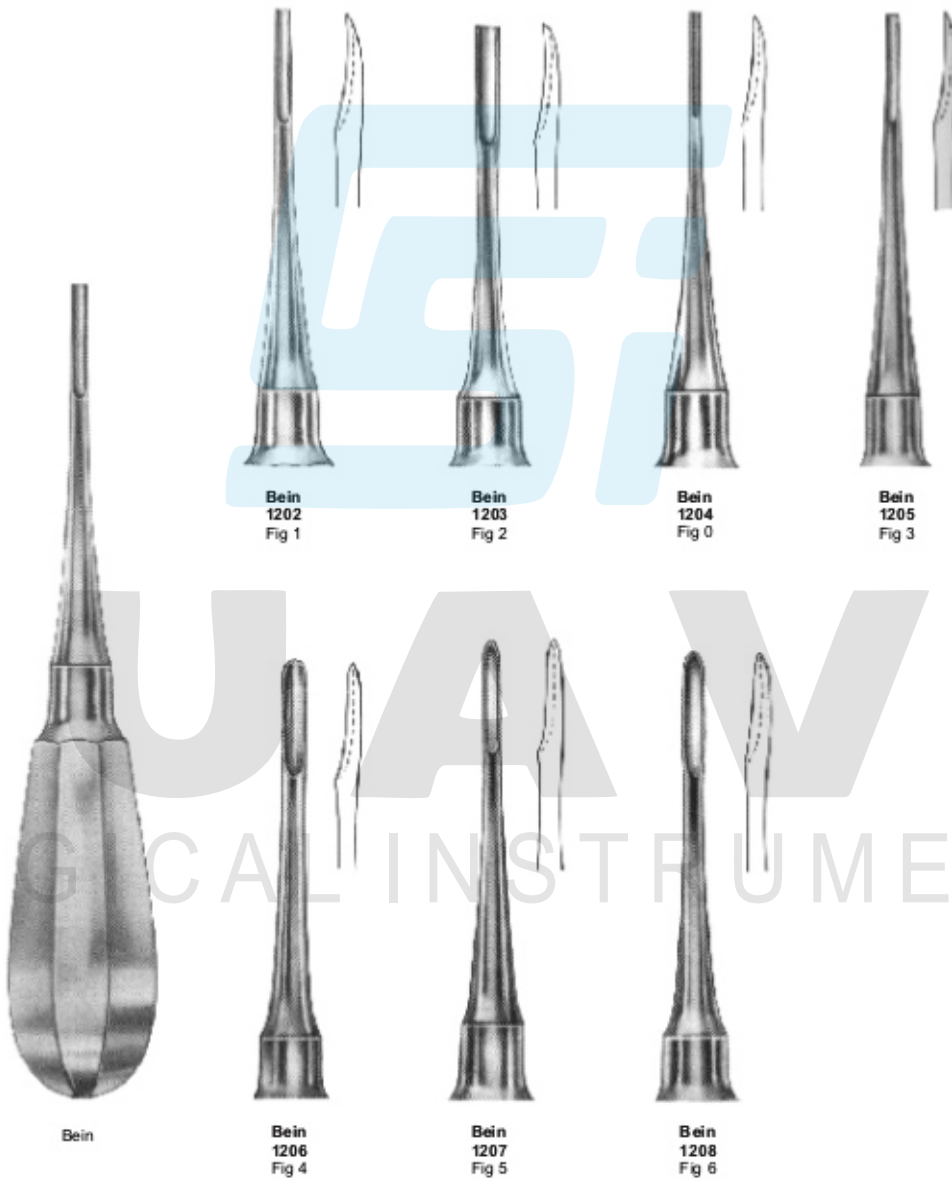

**SUAVE**<sup>®</sup>  
SURGICAL INSTRUMENTS



**RASOOL PUR BHALIAN, LALO KAY, SIALKOT - PAKISTAN**

[www.suavesurgical.com](http://www.suavesurgical.com)  
[info@suavesurgical.com](mailto:info@suavesurgical.com)  
[suavesurgical1988@gmail.com](mailto:suavesurgical1988@gmail.com)





**SUAVE**<sup>®</sup>  
SURGICAL INSTRUMENTS

**Roots Elevators**

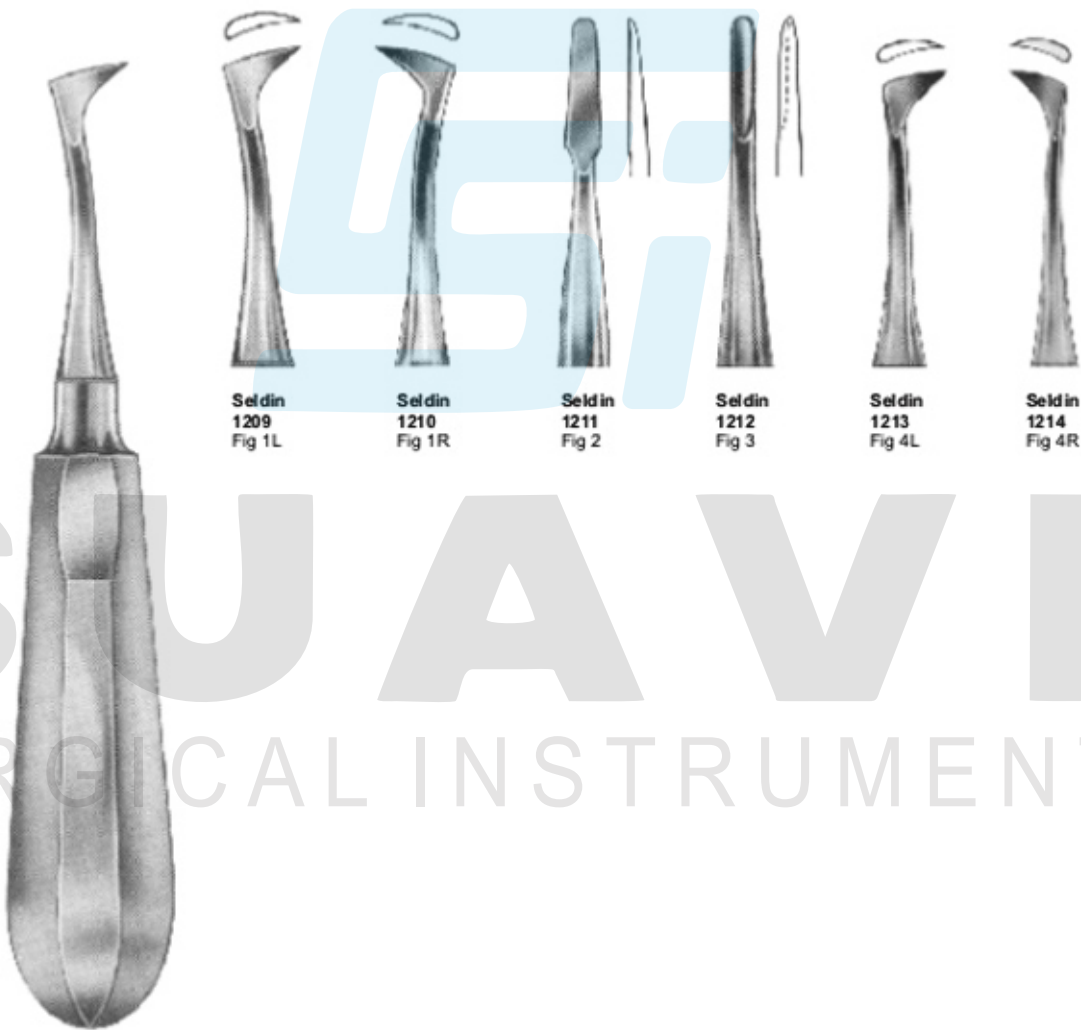

Seldin  
1209  
Fig 1L

Seldin  
1210  
Fig 1R

Seldin  
1211  
Fig 2

Seldin  
1212  
Fig 3

Seldin  
1213  
Fig 4L

Seldin  
1214  
Fig 4R

Seldin

**SUAVE**<sup>®</sup>  
SURGICAL INSTRUMENTS



**RASOOL PUR BHALIAN, LALO KAY, SIALKOT - PAKISTAN**

[www.suavesurgical.com](http://www.suavesurgical.com)  
[info@suavesurgical.com](mailto:info@suavesurgical.com)  
[suavesurgical1988@gmail.com](mailto:suavesurgical1988@gmail.com)

**Roots Elevators**



**SUAVE**<sup>®</sup>  
SURGICAL INSTRUMENTS

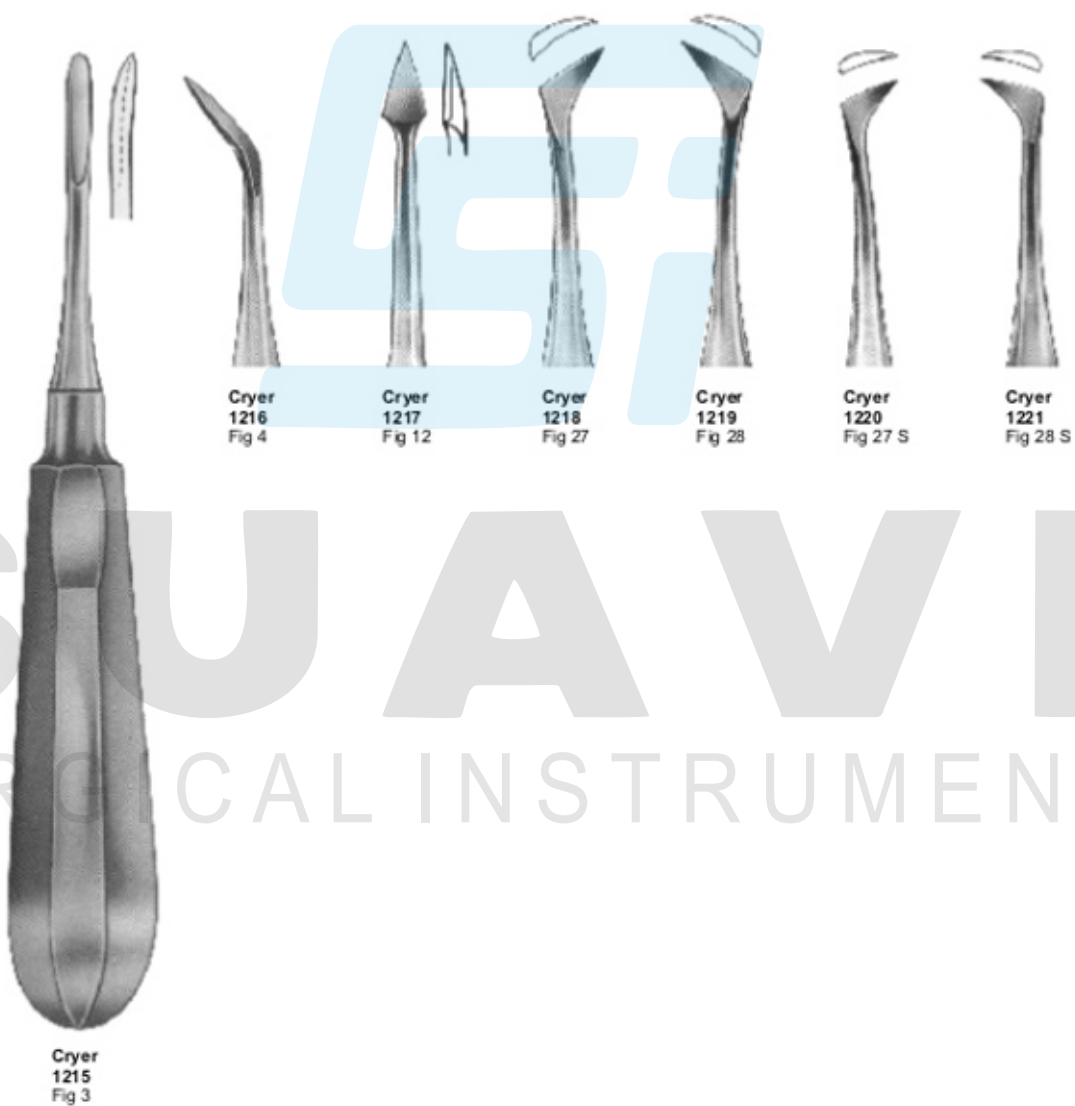

Cryer  
1215  
Fig 3

Cryer  
1216  
Fig 4

Cryer  
1217  
Fig 12

Cryer  
1218  
Fig 27

Cryer  
1219  
Fig 28

Cryer  
1220  
Fig 27 S

Cryer  
1221  
Fig 28 S

**SUAVE**<sup>®</sup>  
SURGICAL INSTRUMENTS



**RASOOL PUR BHALIAN, LALO KAY, SIALKOT - PAKISTAN**

[www.suavesurgical.com](http://www.suavesurgical.com)  
[info@suavesurgical.com](mailto:info@suavesurgical.com)  
[suavesurgical1988@gmail.com](mailto:suavesurgical1988@gmail.com)

**Roots Elevators**



**SUAVE**<sup>®</sup>  
SURGICAL INSTRUMENTS

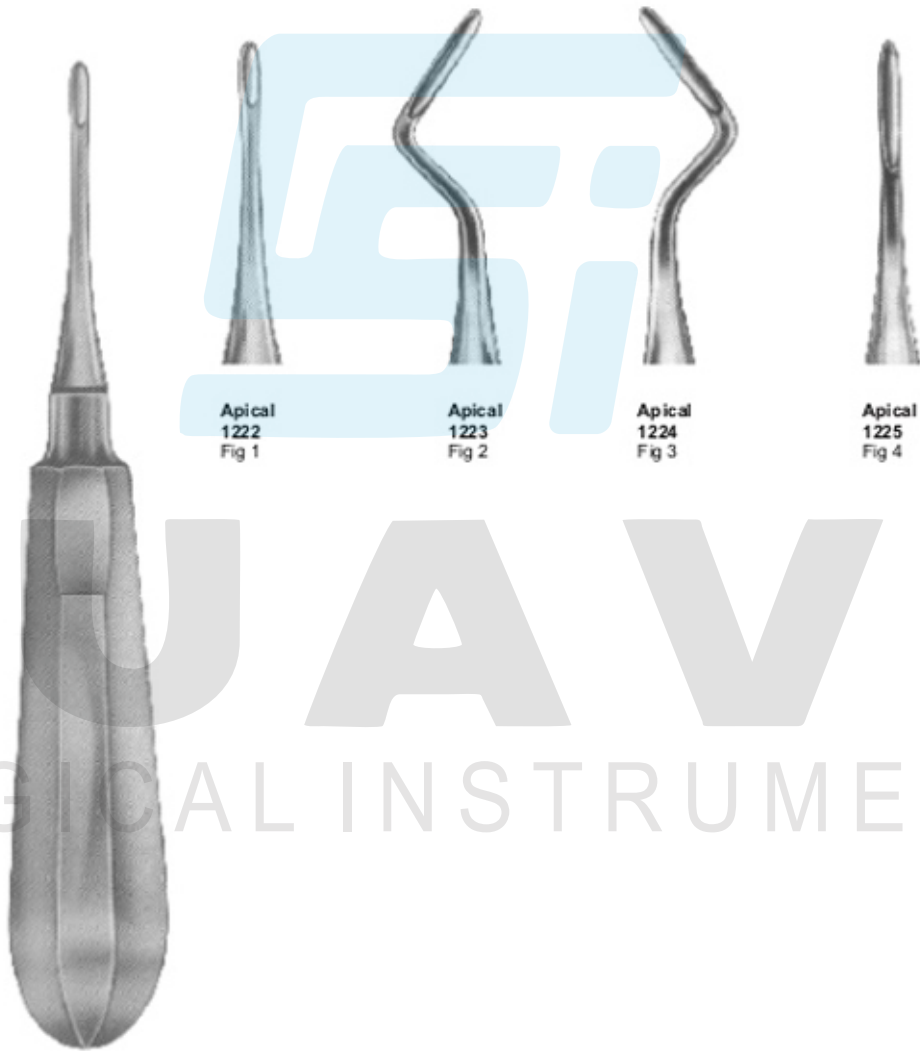

Apical

SUAVE<sup>®</sup>  
SURGICAL INSTRUMENTS



**RASOOL PUR BHALIAN, LALO KAY, SIALKOT - PAKISTAN**

www.suavesurgical.com  
info@suavesurgical.com  
suavesurgical1988@gmail.com



**SUAVE**<sup>®</sup>  
SURGICAL INSTRUMENTS

**Roots Elevators**

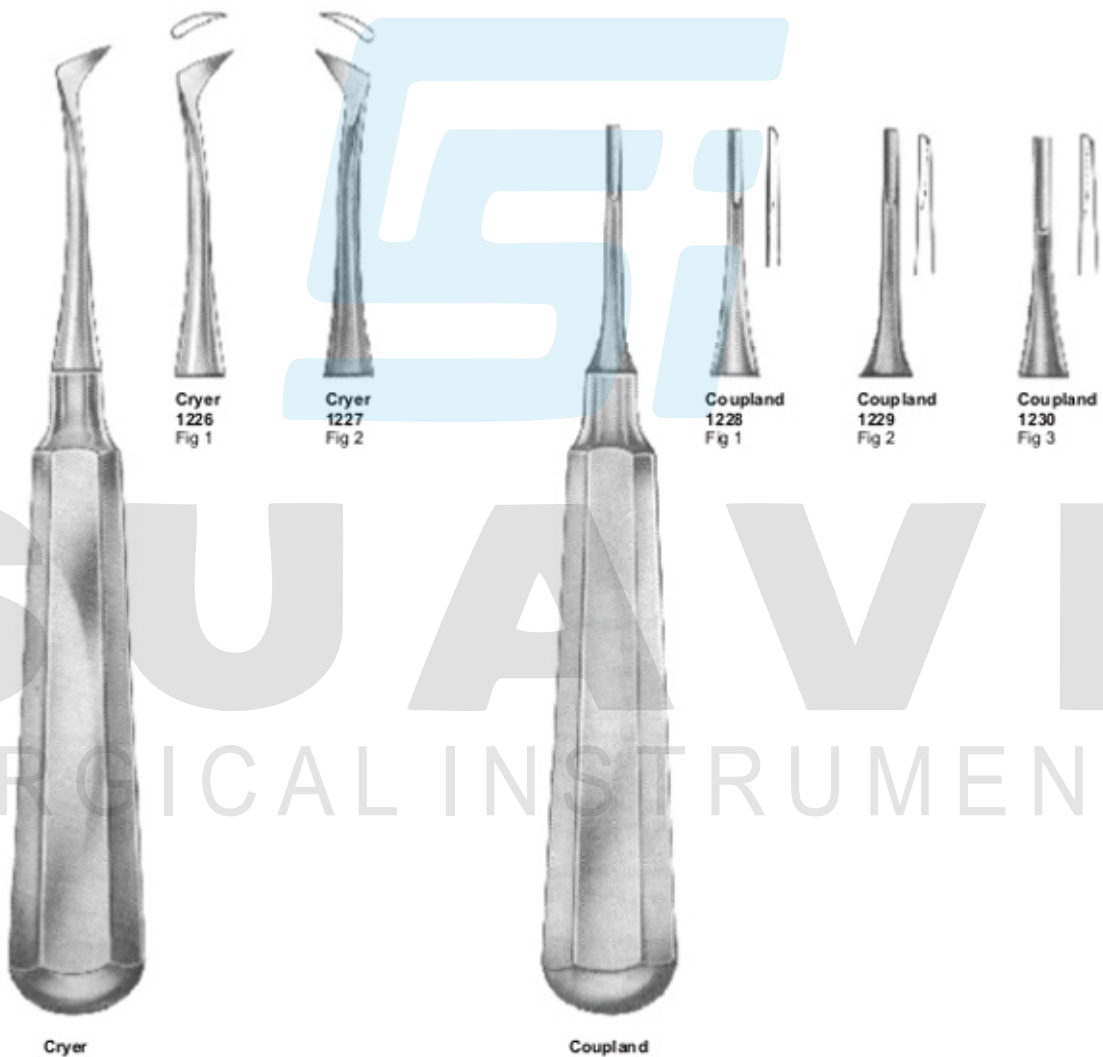

SUAVE<sup>®</sup>  
SURGICAL INSTRUMENTS



**RASOOL PUR BHALIAN, LALO KAY, SIALKOT - PAKISTAN**

www.suavesurgical.com  
info@suavesurgical.com  
suavesurgical1988@gmail.com



**SUAVE**<sup>®</sup>  
SURGICAL INSTRUMENTS

**Roots Elevators**

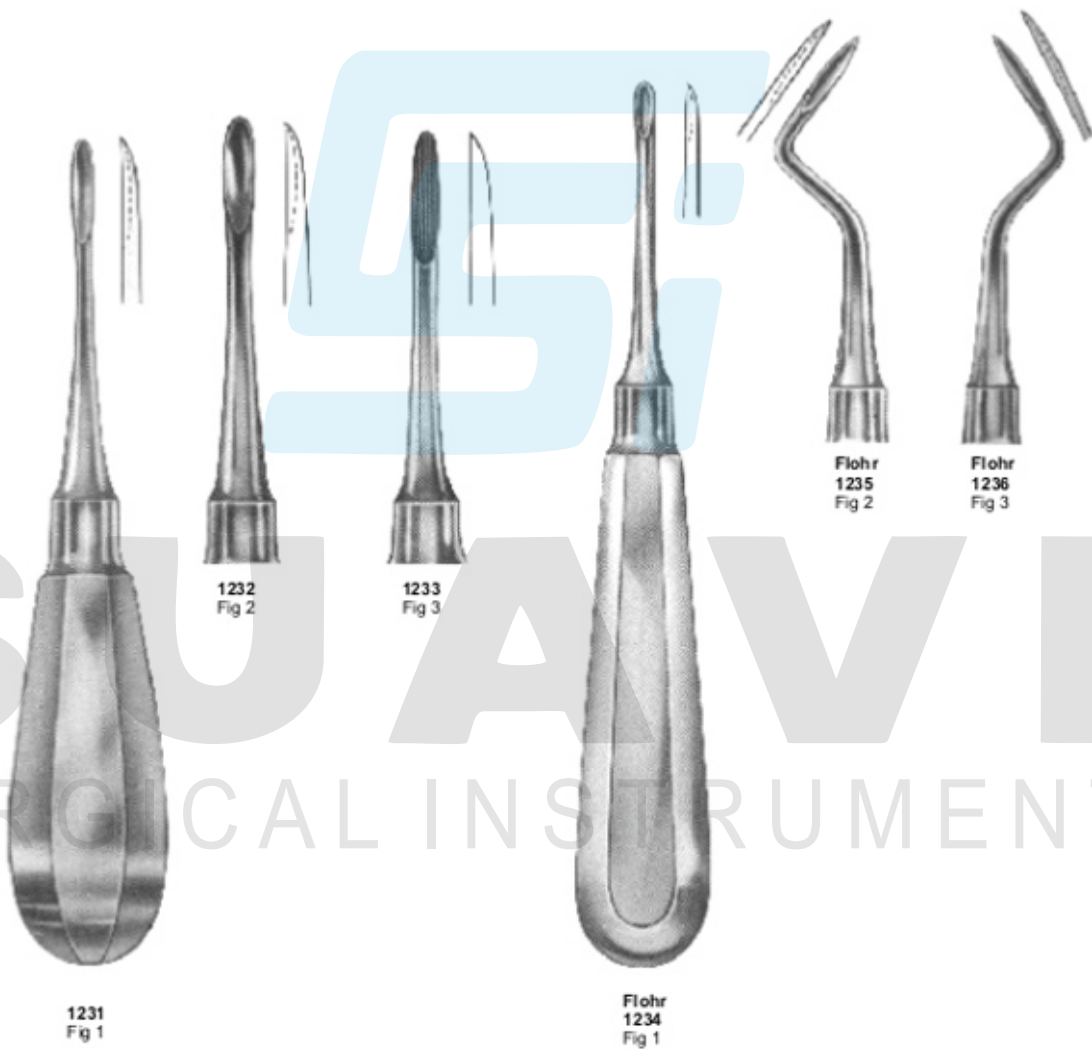

1231  
Fig 1

1232  
Fig 2

1233  
Fig 3

Flohr  
1234  
Fig 1

Flohr  
1235  
Fig 2

Flohr  
1236  
Fig 3



**RASOOL PUR BHALIAN, LALO KAY, SIALKOT - PAKISTAN**

www.suavesurgical.com  
info@suavesurgical.com  
suavesurgical1988@gmail.com





**SUAVE**<sup>®</sup>  
SURGICAL INSTRUMENTS

**Roots Elevators**



Kopp  
1237  
Fig 1



Kopp  
1238  
Fig 2



Kopp  
1243  
Fig 1



Kopp  
1244  
Fig 2



Kopp



Kopp  
1239  
Fig 3



Kopp  
1240  
Fig 4



Kopp



Kopp  
1245  
Fig 3



Kopp  
1246  
Fig 4



Kopp  
1241  
Fig 5



Kopp  
1242  
Fig 6



**Roots Elevators**



**SUAVE**<sup>®</sup>  
SURGICAL INSTRUMENTS

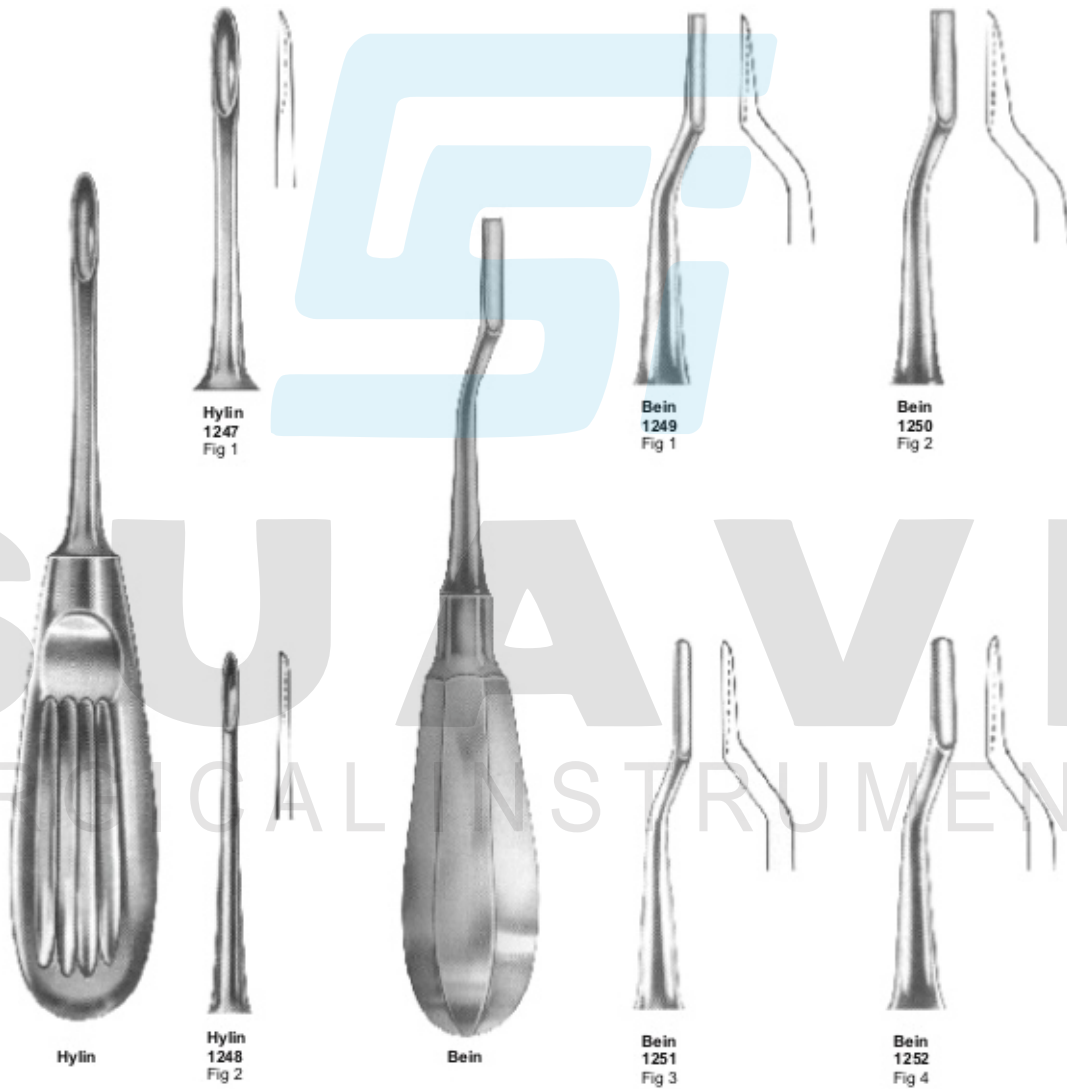

Hylin

Hylin  
1248  
Fig 2

Bein

Bein  
1251  
Fig 3

Bein  
1252  
Fig 4





**SUAVE**<sup>®</sup>  
SURGICAL INSTRUMENTS

**Roots Elevators**

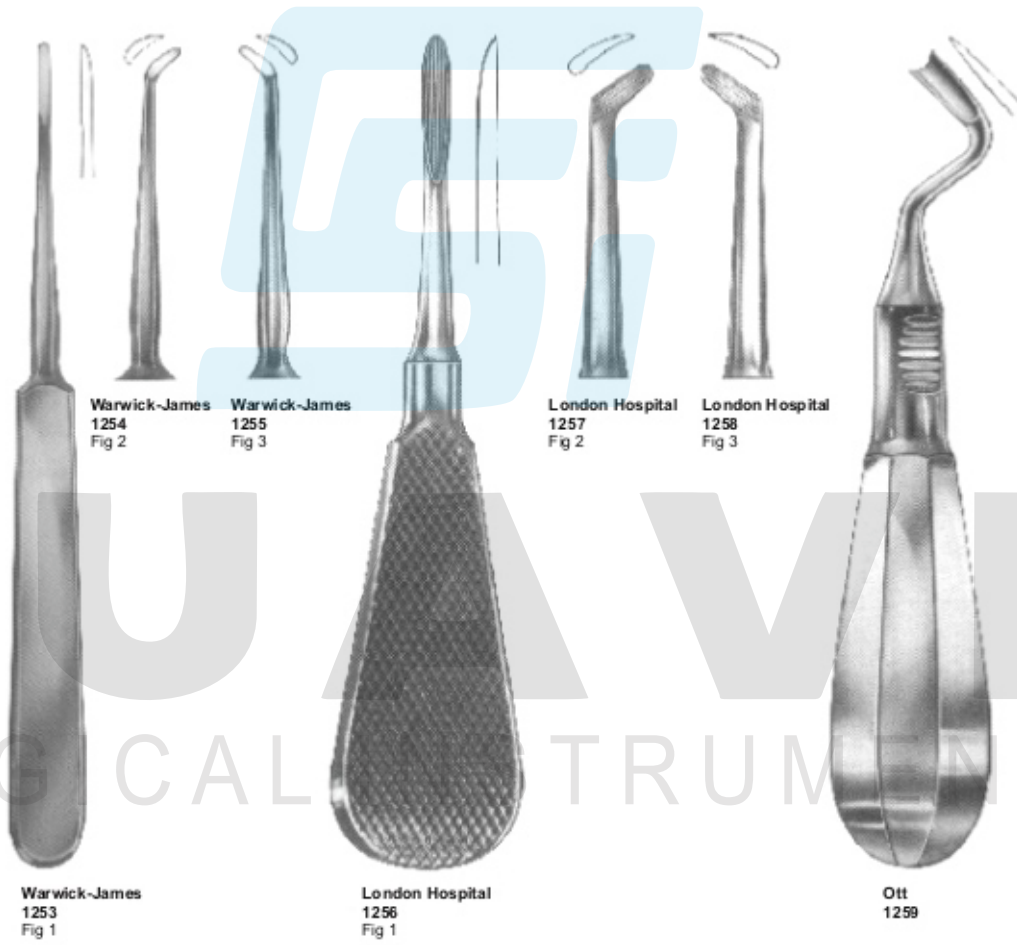

Warwick-James  
1253  
Fig 1

Warwick-James  
1254  
Fig 2

Warwick-James  
1255  
Fig 3

London Hospital  
1256  
Fig 1

London Hospital  
1257  
Fig 2

London Hospital  
1258  
Fig 3

Ott  
1259



**RASOOL PUR BHALIAN, LALO KAY, SIALKOT - PAKISTAN**

www.suavesurgical.com  
info@suavesurgical.com  
suavesurgical1988@gmail.com

**Roots Elevators**



**SUAVE**<sup>®</sup>  
SURGICAL INSTRUMENTS

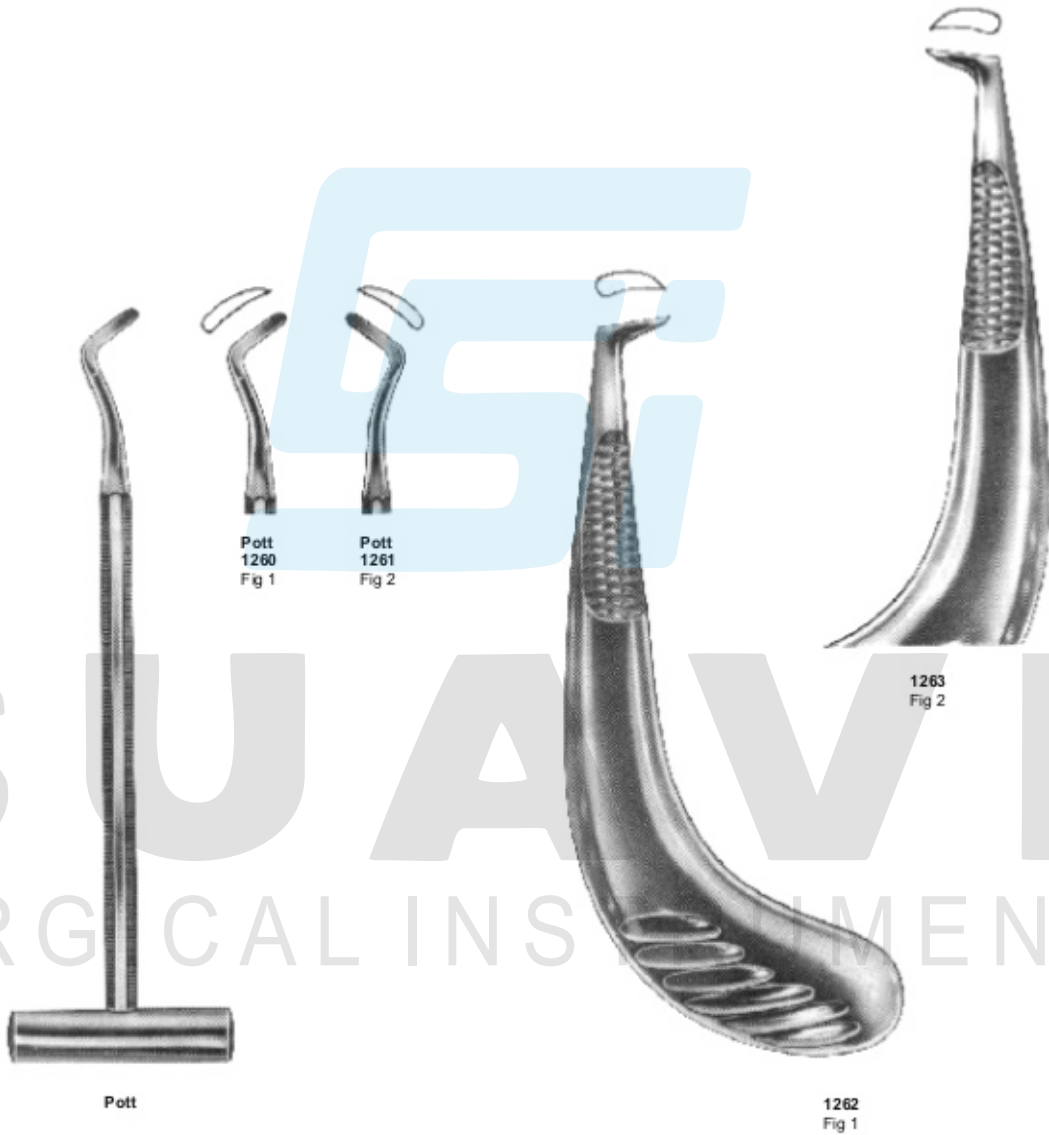



**SUAVE**<sup>®</sup>  
SURGICAL INSTRUMENTS

**Roots Elevators**

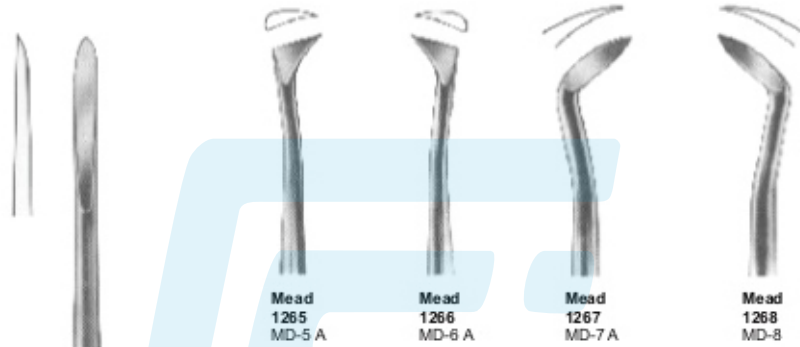

Mead  
1265  
MD-5 A

Mead  
1266  
MD-6 A

Mead  
1267  
MD-7 A

Mead  
1268  
MD-8

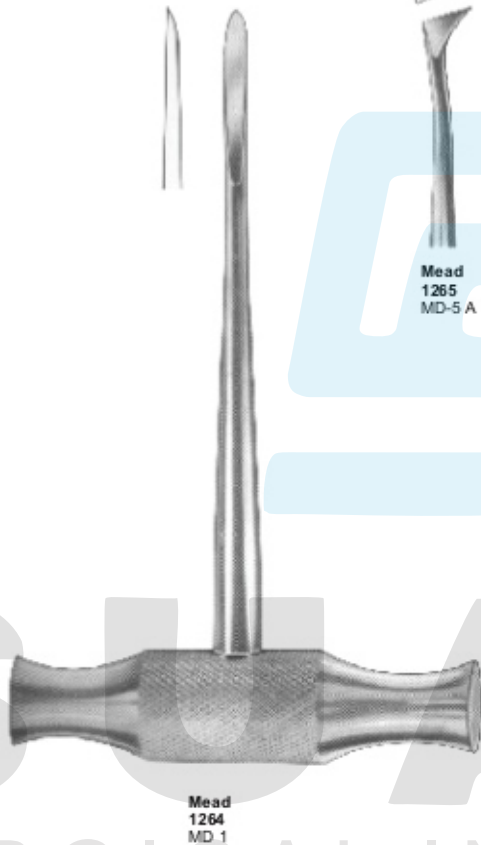

Mead  
1264  
MD 1



Lecluse  
1269





**Roots Elevators**



**SUAVE**<sup>®</sup>  
SURGICAL INSTRUMENTS



Chompret  
1270  
Fig 1



Chompret  
1271  
Fig 2



Chompret  
1272  
Fig 3



Chompret  
1273  
Fig 4



Apical  
1274





**SUAVE**<sup>®</sup>  
SURGICAL INSTRUMENTS

**Roots Elevators**



1275  
Fig 1



1276  
Fig 2



1277  
Fig 3



Heidbrink  
1279  
Fig 2



Heidbrink  
1280  
Fig 3



Heidbrink  
1278  
Fig 1

SUAVE<sup>®</sup>  
SURGICAL INSTRUMENTS



**RASOOL PUR BHALIAN, LALO KAY, SIALKOT - PAKISTAN**

www.suavesurgical.com  
info@suavesurgical.com  
suavesurgical1988@gmail.com



**SUAVE**<sup>®</sup>  
SURGICAL INSTRUMENTS

**Roots Elevators**

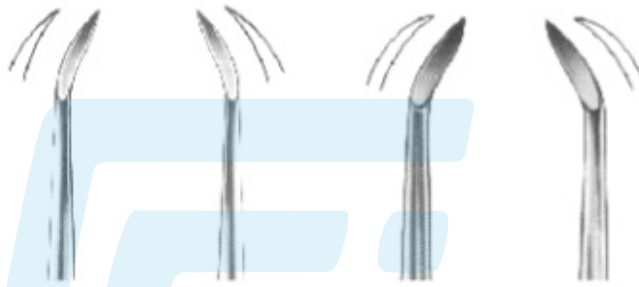

Winter  
1281  
Fig 1L

Winter  
1282  
Fig 1R

Winter  
1283  
Fig 2L

Winter  
1284  
Fig 2R



Winter  
1285  
Fig 11 L



Winter  
1286  
Fig 11 R



Winter  
1287  
Fig 12 L



Winter  
1288  
Fig 12 R

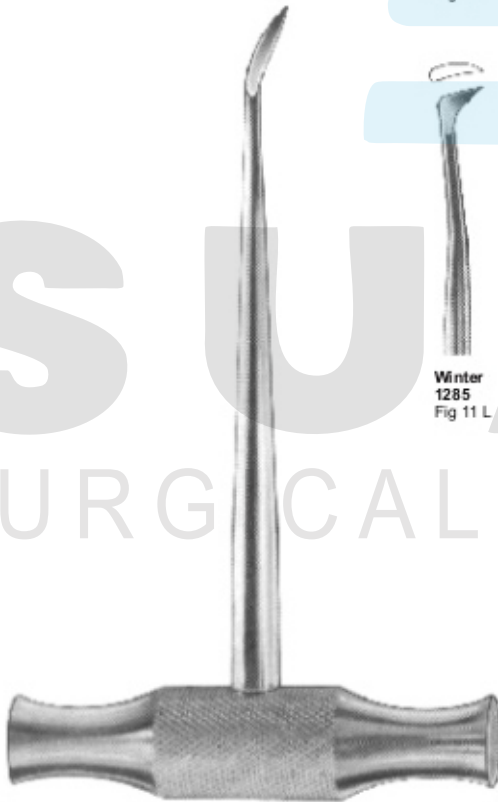

Winter



Winter  
1289  
Fig 14 L



Winter  
1290  
Fig 14 R





**Roots Elevators**



**SUAVE**<sup>®</sup>  
SURGICAL INSTRUMENTS



Barry  
1291  
Fig 1



Barry  
1292  
Fig 2



Barry  
1293  
Fig 3



Barry  
1294  
Fig 4

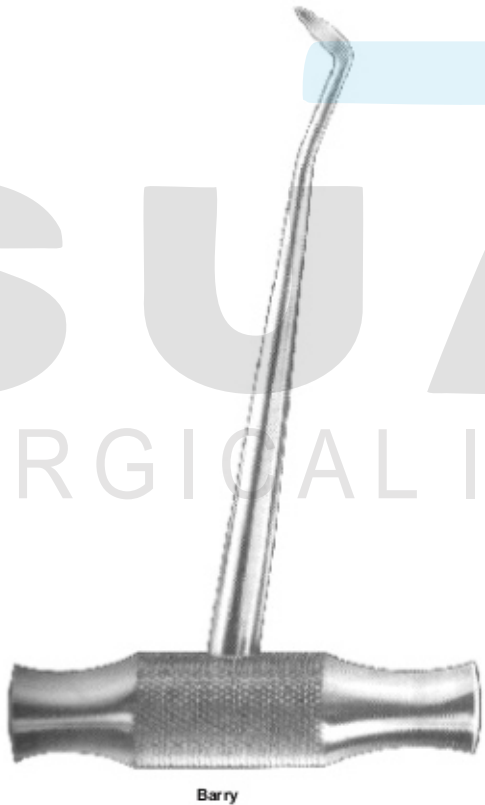

Barry



Barry  
1295  
Fig 11



Barry  
1296  
Fig 12



Barry  
1297  
Fig 17



Barry  
1298  
Fig 18





**SUAVE**<sup>®</sup>  
SURGICAL INSTRUMENTS

**Roots Elevators**



Cryer  
1300  
Fig 26



Seldin  
1301  
Fig 27



Cryer  
1302  
Fig 28



Cryer  
1303  
Fig 29



Heidbrink  
1304  
Fig 22



Heidbrink  
1305  
Fig 23



1299



**RASOOL PUR BHALIAN, LALO KAY, SIALKOT - PAKISTAN**

[www.suavesurgical.com](http://www.suavesurgical.com)  
[info@suavesurgical.com](mailto:info@suavesurgical.com)  
[suavesurgical1988@gmail.com](mailto:suavesurgical1988@gmail.com)



**SUAVE**<sup>®</sup>  
SURGICAL INSTRUMENTS

**Roots Elevators**



Kopp  
1307  
Fig 31



Kopp  
1308  
Fig 32



Kopp  
1309  
Fig 33



Kopp  
1310  
Fig 34



Kopp  
1311  
Fig 35



Kopp  
1312  
Fig 44

SUAVE<sup>®</sup>  
SURGICAL INSTRUMENTS

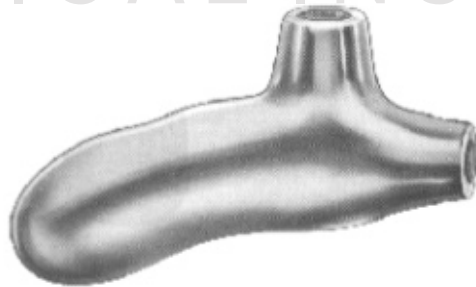

1306



**RASOOL PUR BHALIAN, LALO KAY, SIALKOT - PAKISTAN**

[www.suavesurgical.com](http://www.suavesurgical.com)  
[info@suavesurgical.com](mailto:info@suavesurgical.com)  
[suavesurgical1988@gmail.com](mailto:suavesurgical1988@gmail.com)



**Roots Elevators**



**SUAVE**<sup>®</sup>  
SURGICAL INSTRUMENTS

Root Elevators according to Dr. Sader,  
with interchangeable working tips



1321

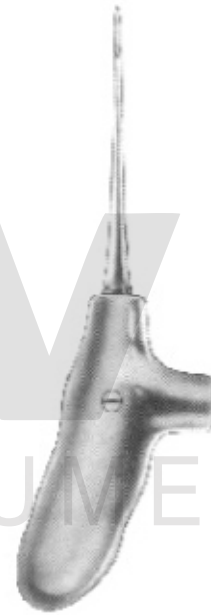

1322

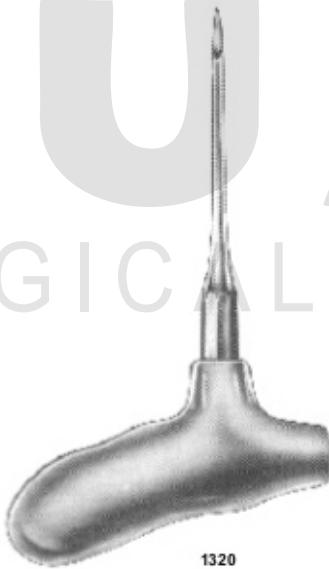

1320

SUAVE<sup>®</sup>  
SURGICAL INSTRUMENTS



**RASOOL PUR BHALIAN, LALO KAY, SIALKOT - PAKISTAN**

[www.suavesurgical.com](http://www.suavesurgical.com)  
[info@suavesurgical.com](mailto:info@suavesurgical.com)  
[suavesurgical1988@gmail.com](mailto:suavesurgical1988@gmail.com)

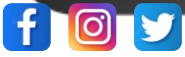

**SUAVE**<sup>®</sup>  
SURGICAL INSTRUMENTS

**Filling Instruments**

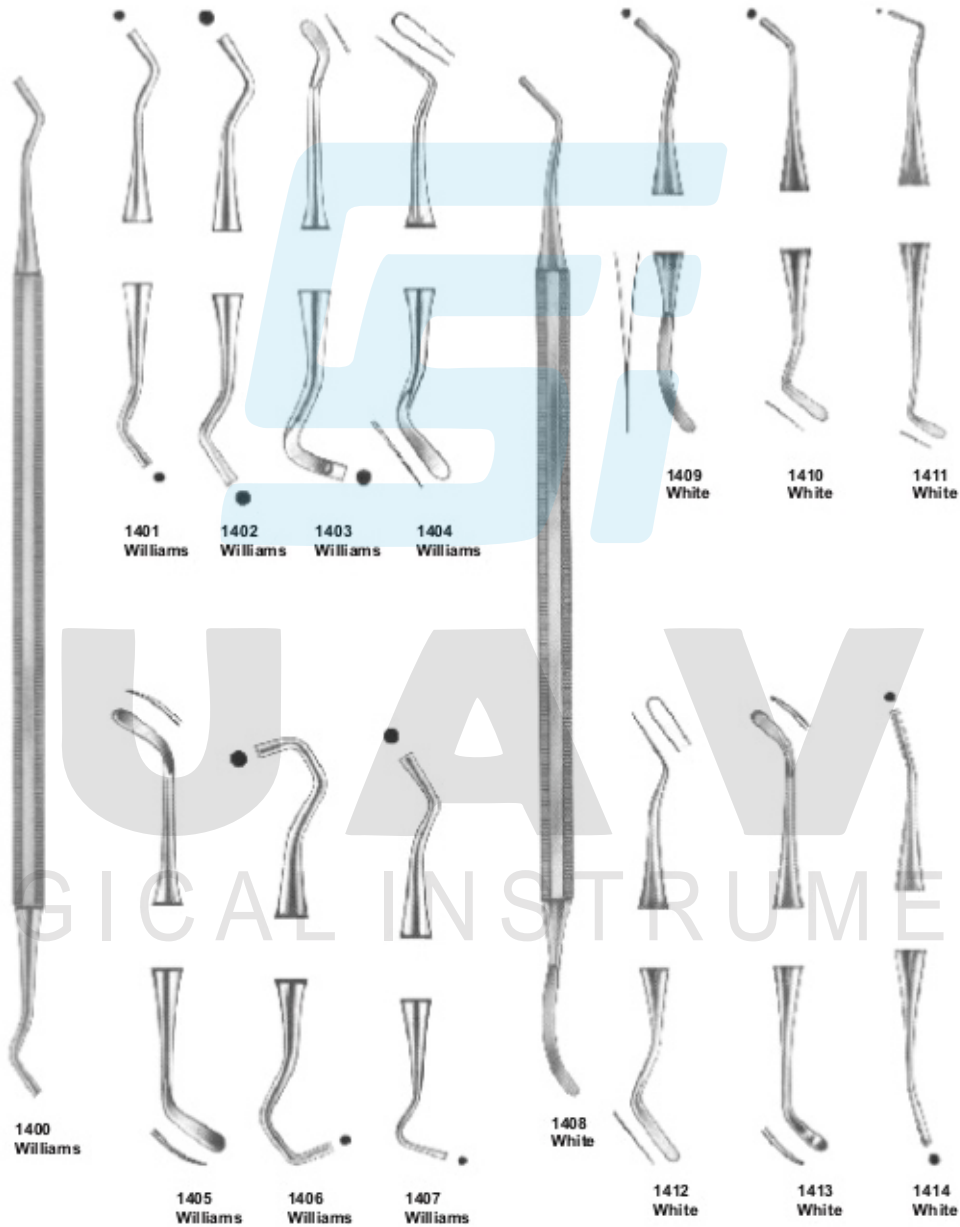

**RASOOL PUR BHALIAN, LALO KAY, SIALKOT - PAKISTAN**

www.suavesurgical.com  
info@suavesurgical.com  
suavesurgical1988@gmail.com



**SUAVE**<sup>®</sup>  
SURGICAL INSTRUMENTS

**Filling Instruments**

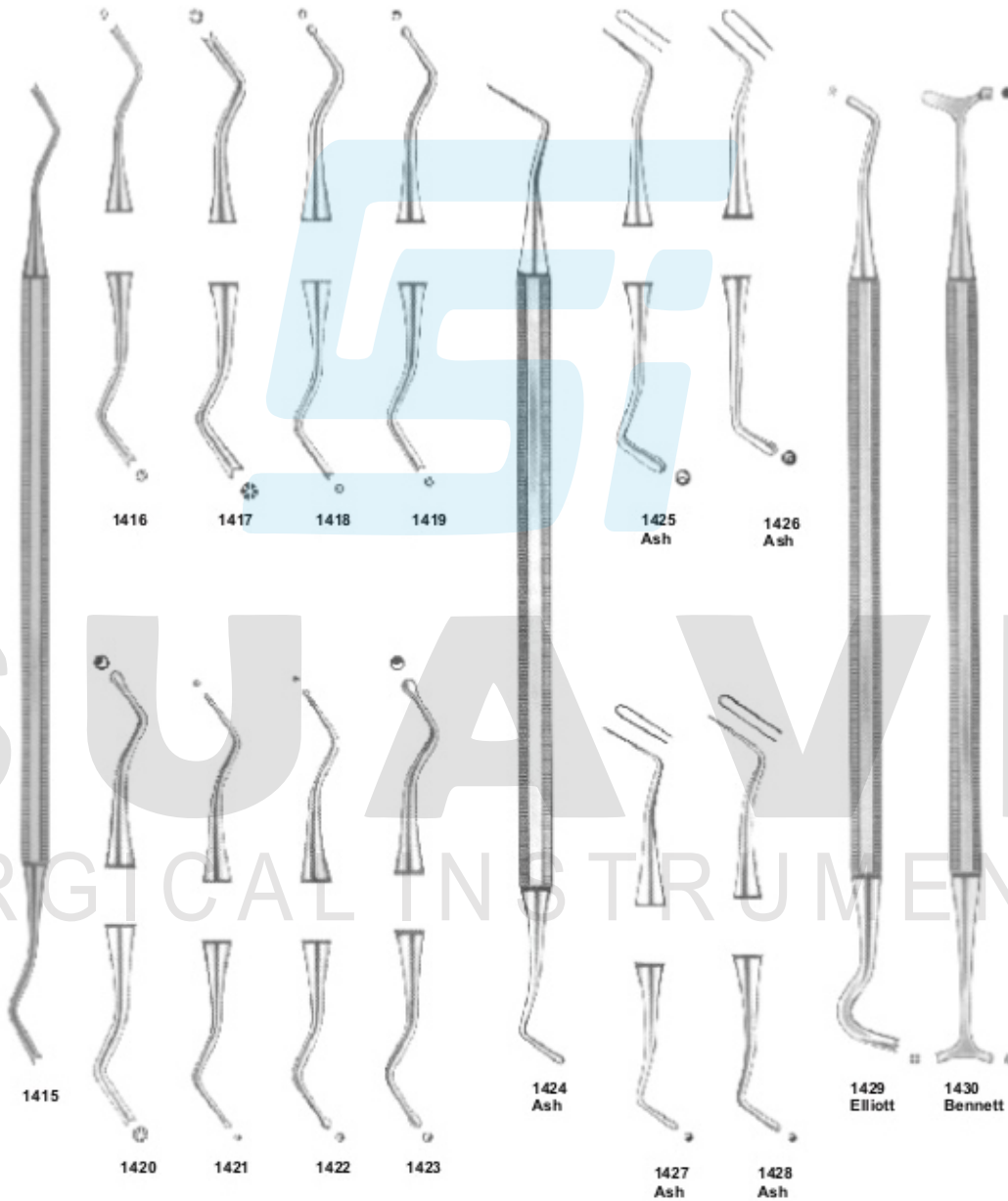

**RASOOL PUR BHALIAN, LALO KAY, SIALKOT - PAKISTAN**

www.suavesurgical.com  
info@suavesurgical.com  
suavesurgical1988@gmail.com



**SUAVE**<sup>®</sup>  
SURGICAL INSTRUMENTS

**Filling Instruments**

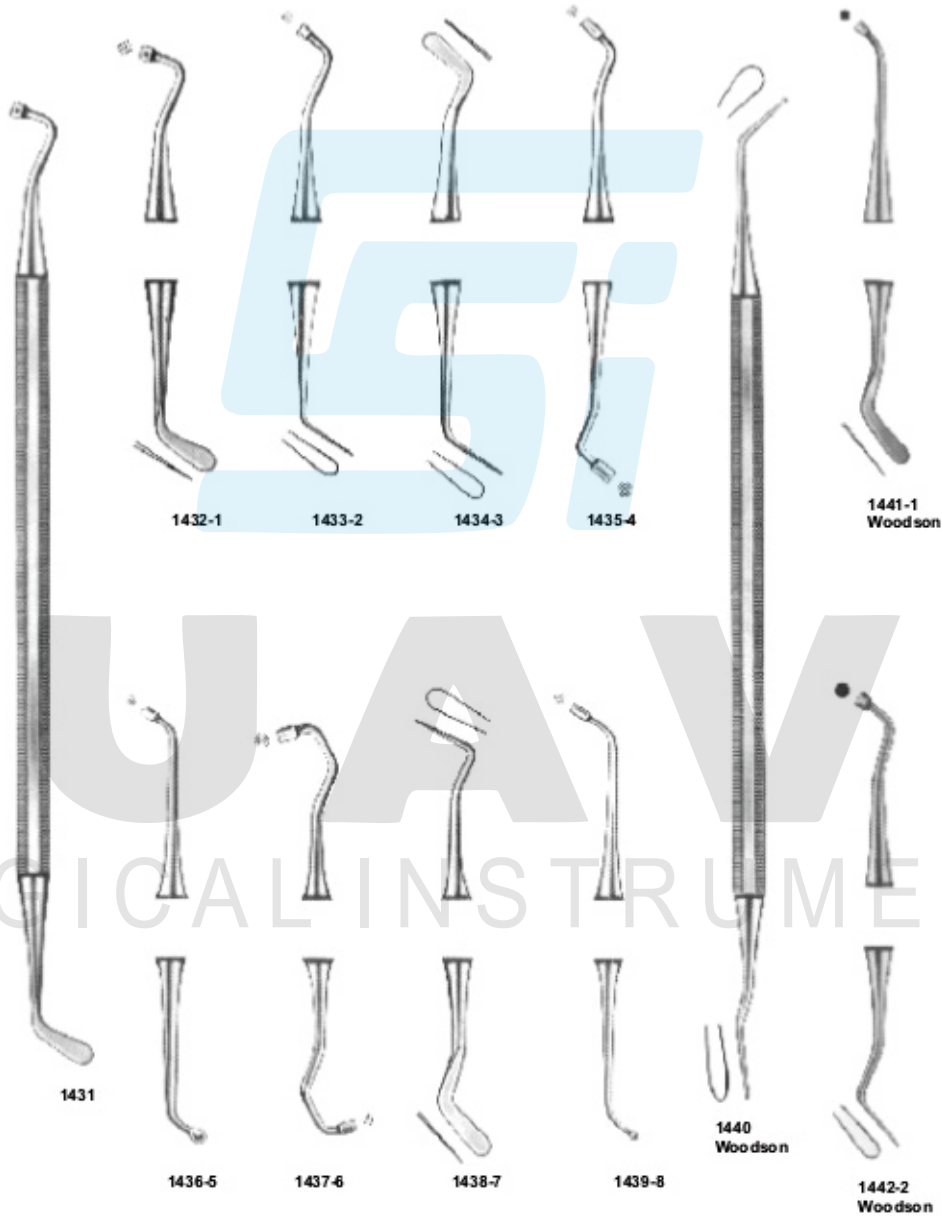

**RASOOL PUR BHALIAN, LALO KAY, SIALKOT - PAKISTAN**

www.suavesurgical.com  
info@suavesurgical.com  
suavesurgical1988@gmail.com



**Filling Instruments**



**SUAVE**<sup>®</sup>  
SURGICAL INSTRUMENTS

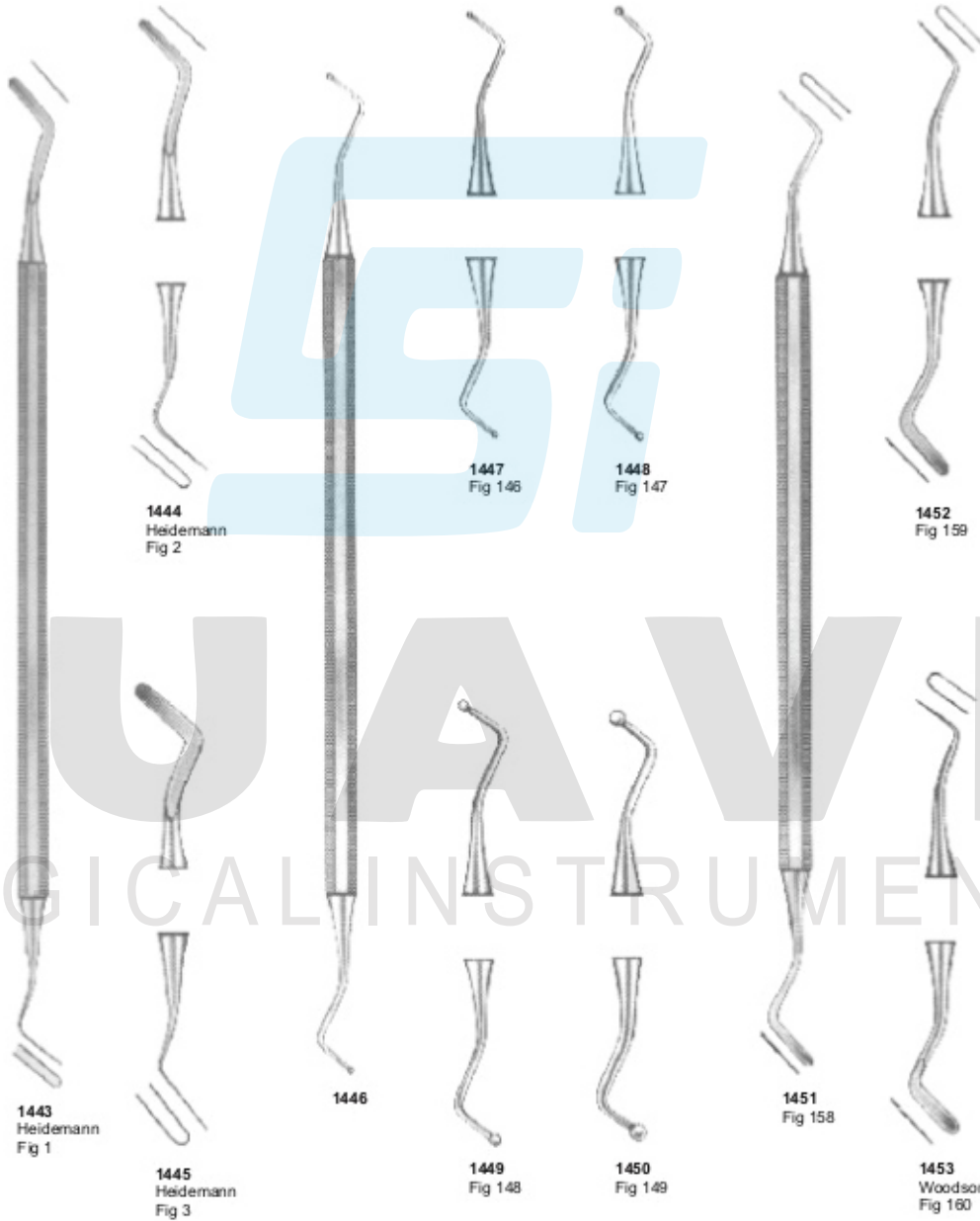

**RASOOL PUR BHALIAN, LALO KAY, SIALKOT - PAKISTAN**

www.suavesurgical.com  
info@suavesurgical.com  
suavesurgical1988@gmail.com



**Periodontal Curetters and  
Filling Instruments**



**SUAVE**<sup>®</sup>  
SURGICAL INSTRUMENTS

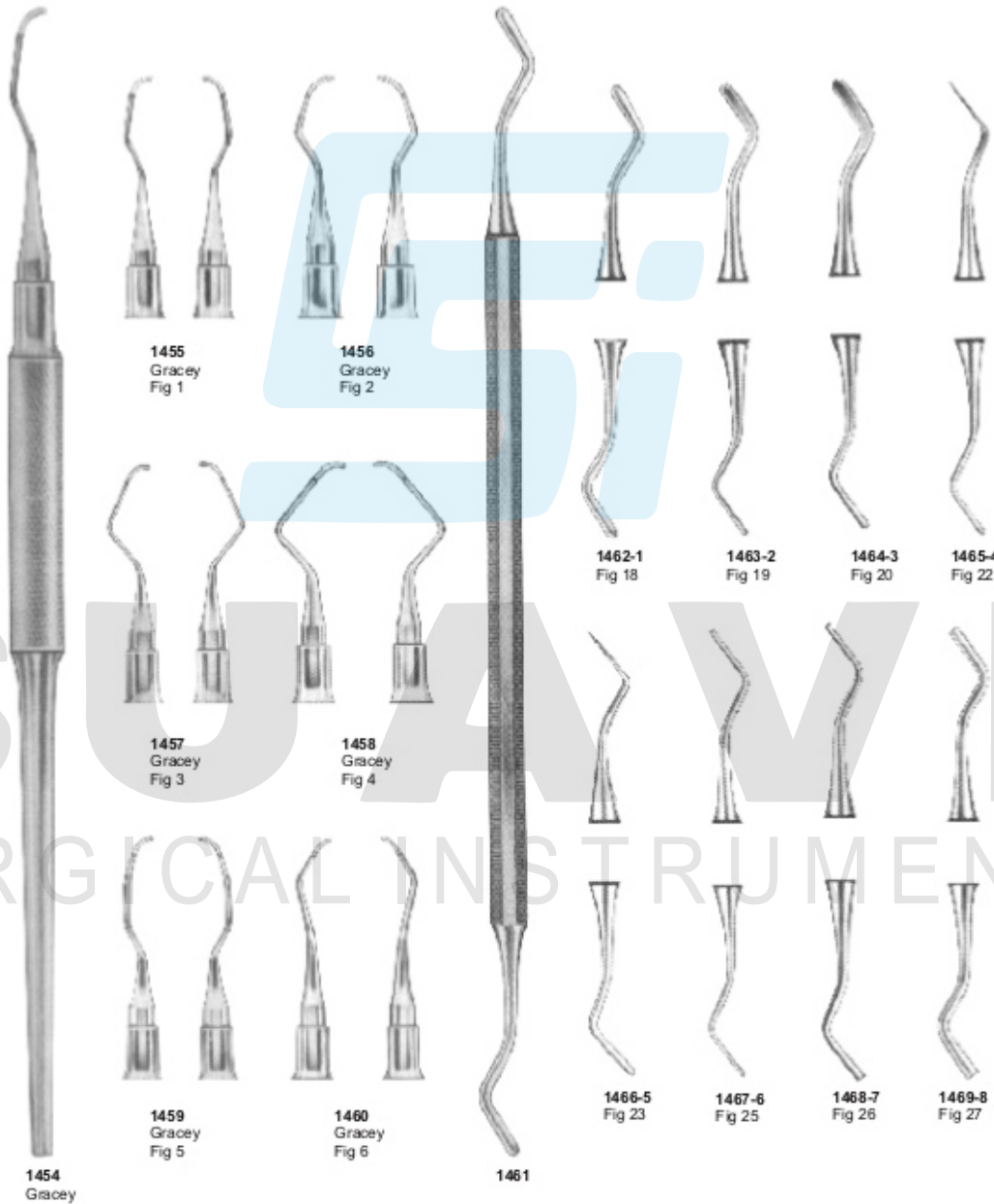

**RASOOL PUR BHALIAN, LALO KAY, SIALKOT - PAKISTAN**

www.suavesurgical.com  
info@suavesurgical.com  
suavesurgical1988@gmail.com





**SUAVE**<sup>®</sup>  
SURGICAL INSTRUMENTS

**Dntal Probes**

With Point Set In



1470



1471-1



1472-2



1473-3



1474-4



1475-5



1476-6



1477-7



1478-8



1479-9



1480-10



1481-11



1482-2  
Woodson



**RASOOL PUR BHALIAN, LALO KAY, SIALKOT - PAKISTAN**

www.suavesurgical.com  
info@suavesurgical.com  
suavesurgical1988@gmail.com

**Burmishers and Probes Scalers**



**SUAVE**<sup>®</sup>  
SURGICAL INSTRUMENTS

Polishing Instruments

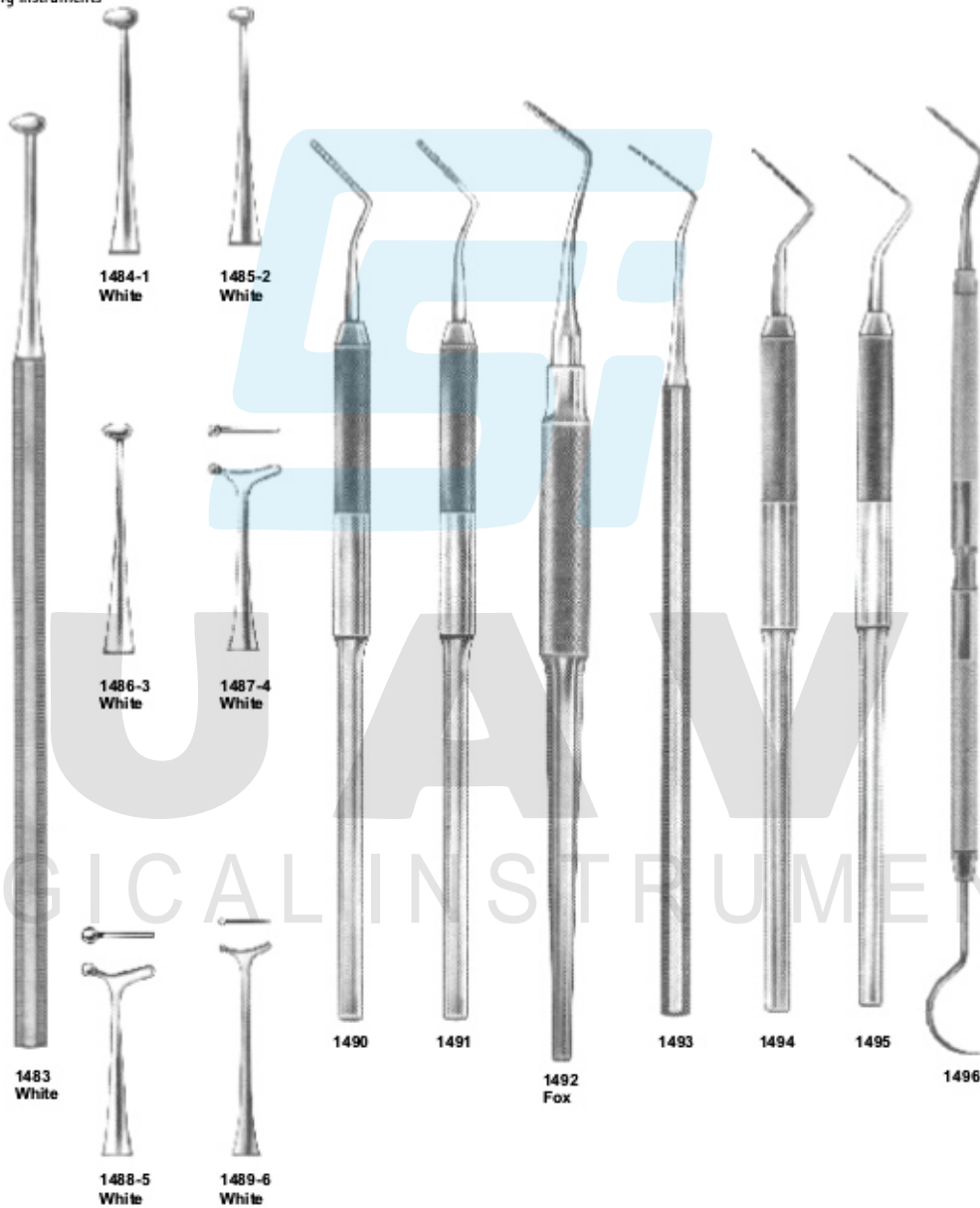

**RASOOL PUR BHALIAN, LALO KAY, SIALKOT - PAKISTAN**

www.suavesurgical.com  
info@suavesurgical.com  
suavesurgical1988@gmail.com



**Periodontal Pocket Probes**



**SUAVE**<sup>®</sup>  
SURGICAL INSTRUMENTS



- New marking process.
- Laser system marking.
- No more paint peeling off.
- Permanent marking.
- Antiglare low depth marking.
- Maximum tip resistance against breaking.

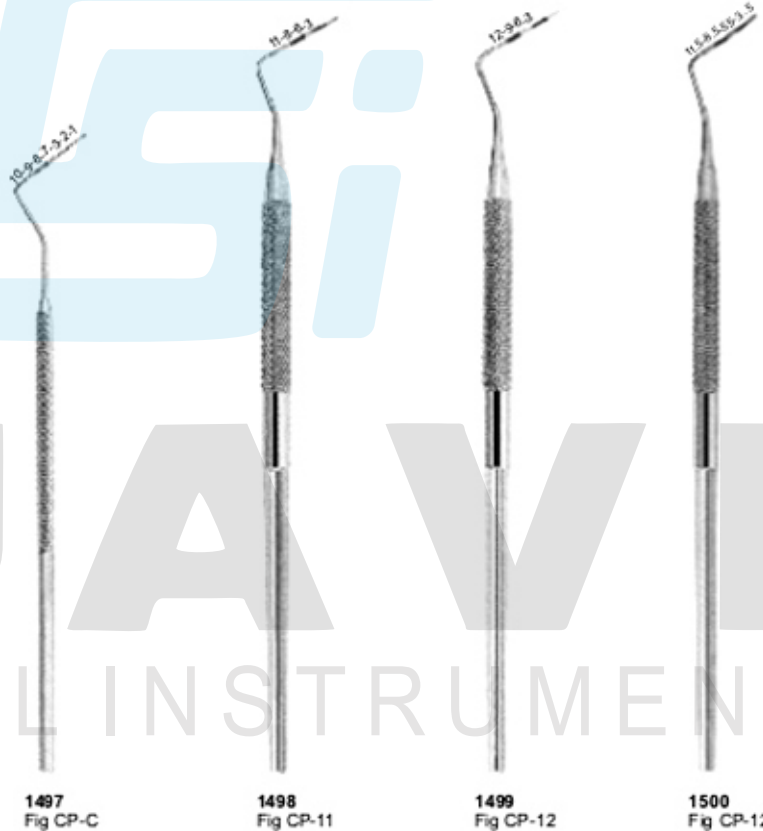

1497  
Fig CP-C

1498  
Fig CP-11

1499  
Fig CP-12

1500  
Fig CP-12S  
O.M.S



**RASOOL PUR BHALIAN, LALO KAY, SIALKOT - PAKISTAN**

[www.suavesurgical.com](http://www.suavesurgical.com)  
[info@suavesurgical.com](mailto:info@suavesurgical.com)  
[suavesurgical1988@gmail.com](mailto:suavesurgical1988@gmail.com)

**Periodontal Pocket Probes**



**SUAVE**<sup>®</sup>  
SURGICAL INSTRUMENTS



1501  
Williams

1502  
Meirit A

1503  
Meirit B

1504  
Goldman  
Fox

1505  
University of  
Michigan

1506  
26 G



**RASOOL PUR BHALIAN, LALO KAY, SIALKOT - PAKISTAN**

[www.suavesurgical.com](http://www.suavesurgical.com)  
[info@suavesurgical.com](mailto:info@suavesurgical.com)  
[suavesurgical1988@gmail.com](mailto:suavesurgical1988@gmail.com)



**Periodontia Instruments**

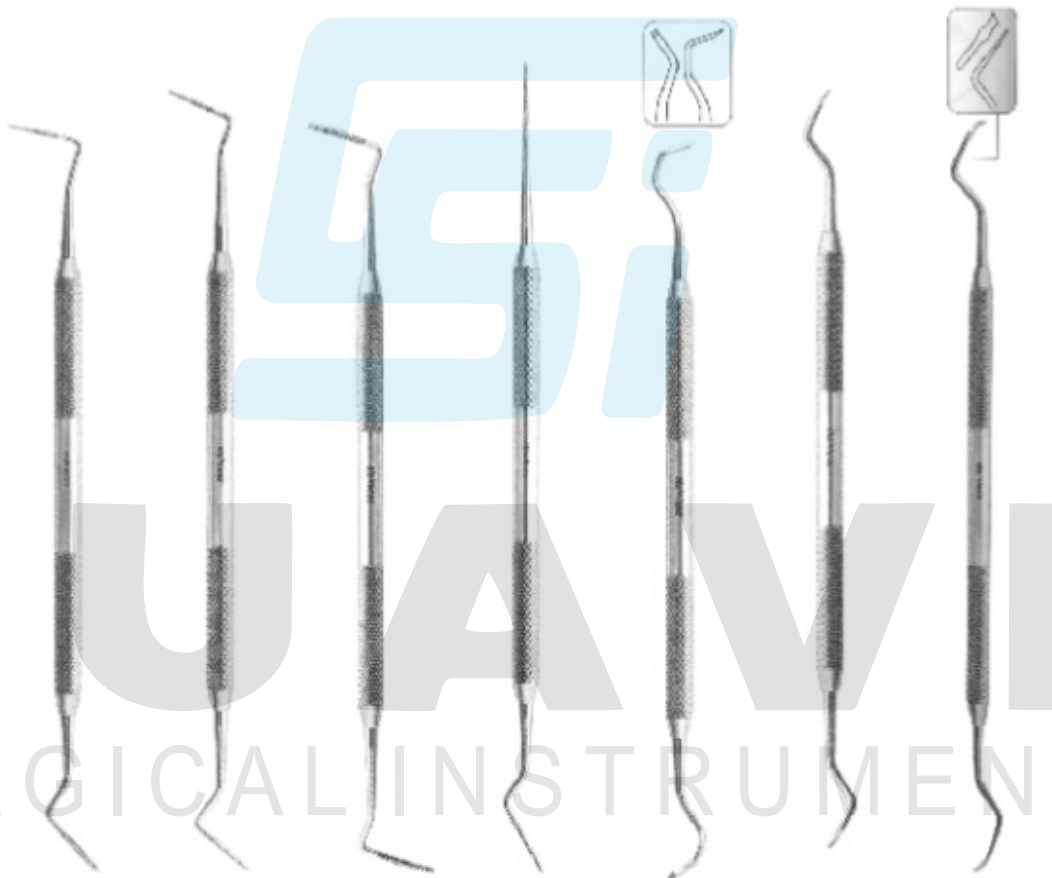

1507  
Sugarman  
Fig. 15/25

1508  
Sugarman  
Fig. 35/45

1509  
Schluger  
Fig. 9/10

1510  
Buck  
Fig. 11/12

1511  
Ochsenbein  
Fig. 3

1512  
Ochsenbein  
Fig. 4

1513  
Rhodes  
Back - Action  
Fig. 36/37



**Periodontia Instruments**



Gingivectomy knives



1521  
Goldman-Fox  
Fig. 7

1522  
Goldman-Fox  
Fig. 8

1523  
Goldman-Fox  
Fig. 9

1524  
Goldman-Fox  
Fig. 11

1525  
Buck  
Fig. 3/4

1526  
Buck  
Fig. 5/6





**Periodontia Instruments**



Curettes and Scalers

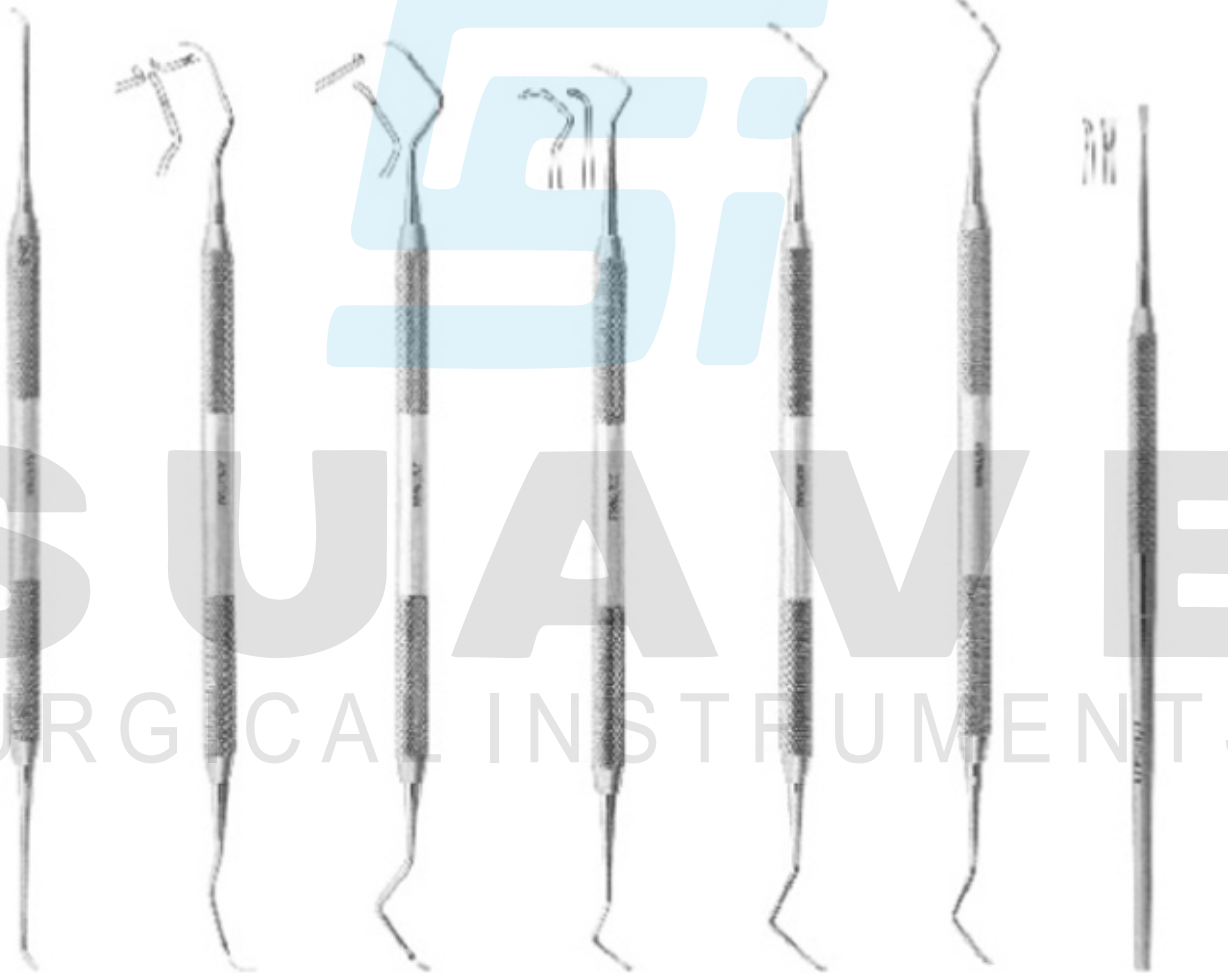

1527  
Curette  
Fig. HU 1/2

1528  
Columbia  
Fig. 2R/2L

1529  
Columbia  
Fig. 4R/4L

1530  
Columbia  
Fig. 13/14

1531  
Fig. 411/412

1532  
Fig. 413/414

1533  
Zerfing-chisel



**Periodontia Instruments**



Gingivectomy knives

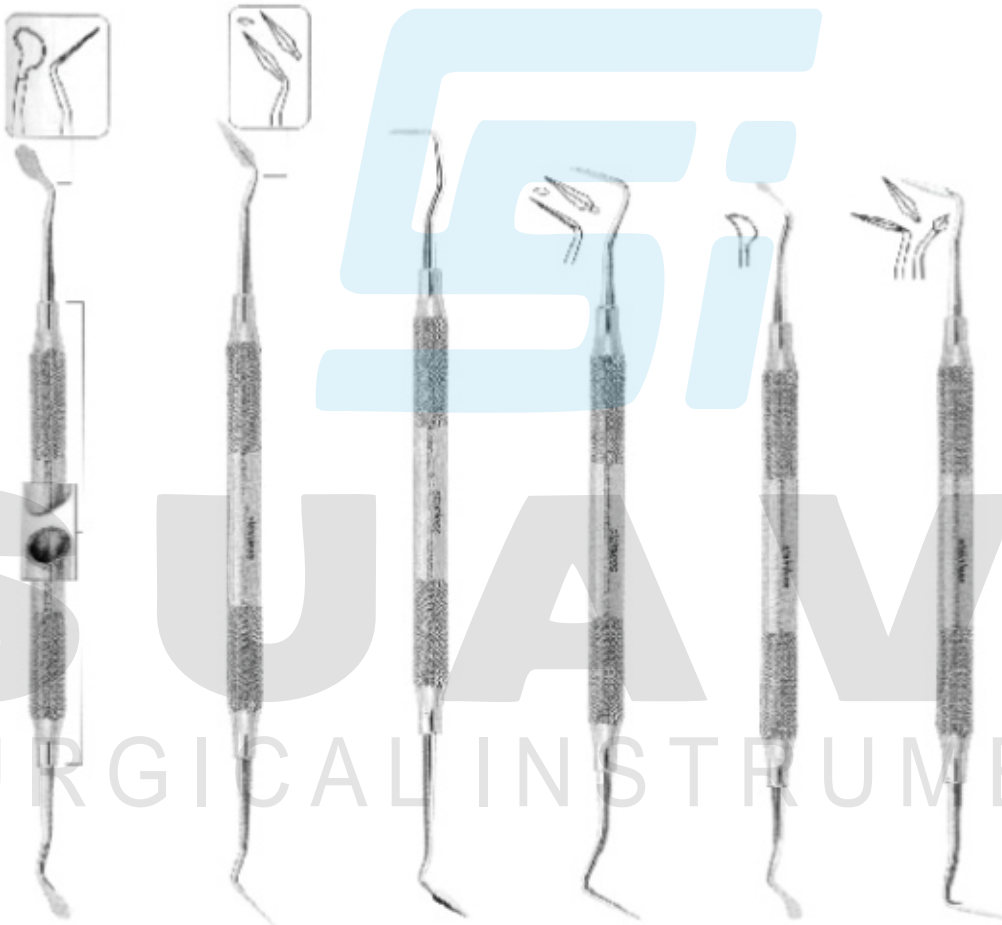

1534  
Goldman - Fox  
Fig. 7

1535  
Goldman - Fox  
Fig. 8

1536  
Goldman - Fox  
Fig. 9

1537  
Goldman - Fox  
Fig. 11

1538  
Buck  
Fig. 3/4

1539  
Buck  
Fig. 5/6



**Periodontia Instruments**



Curettes and Scalers

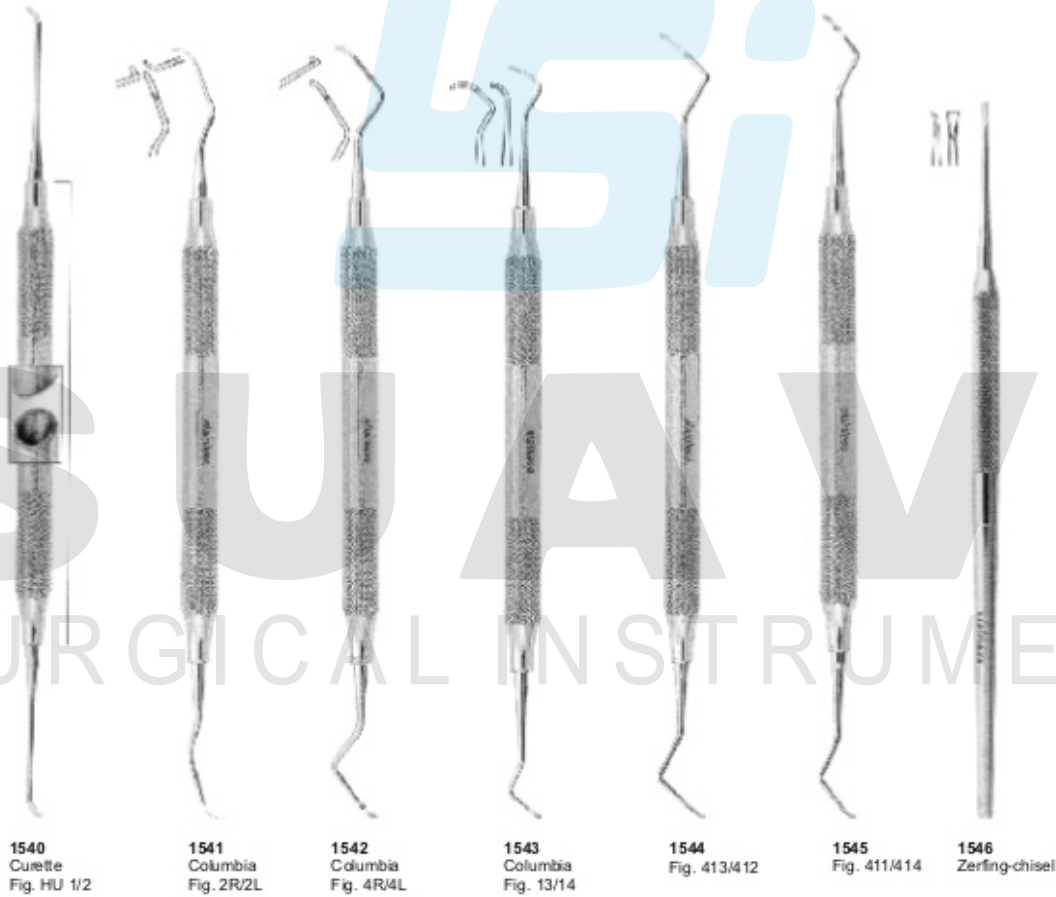

**Periodontia Instruments**



Bone Chisels and Gouges



1547 Ochsenbein Fig. 1    1548 Ochsenbein Fig. 2    1549 Gardner Fig. 1    1550 Gardner Fig. 2    1551 Gardner Fig. 5    1552 Gardner Fig. 5R    1553 Gardner Fig. 6    1554 Wakefield Fig. 1W    1555 Wakefield Fig. 2W    1556 Buckley Fig. 3





**SUAVE**<sup>®</sup>  
SURGICAL INSTRUMENTS

**Periodontia Instruments and Mallets**

Bone Chisels and Gouges

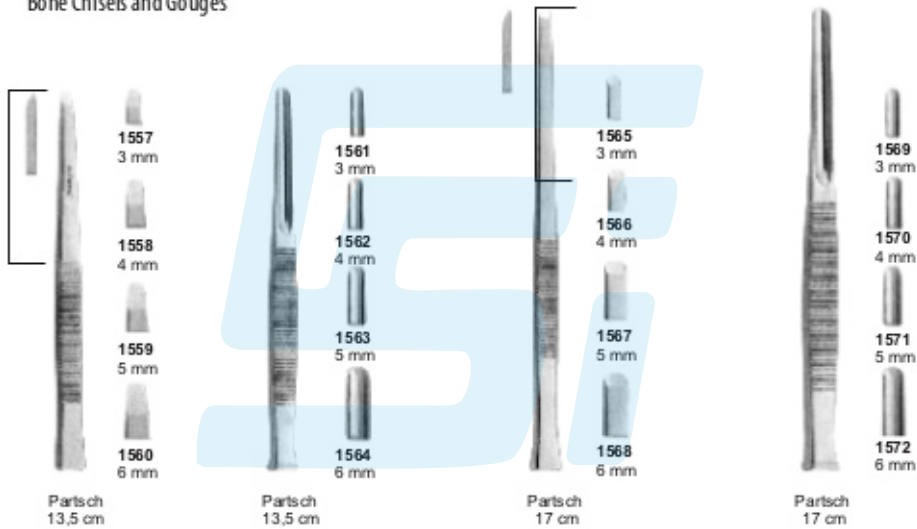

Martelli chirurgici  
Mallet

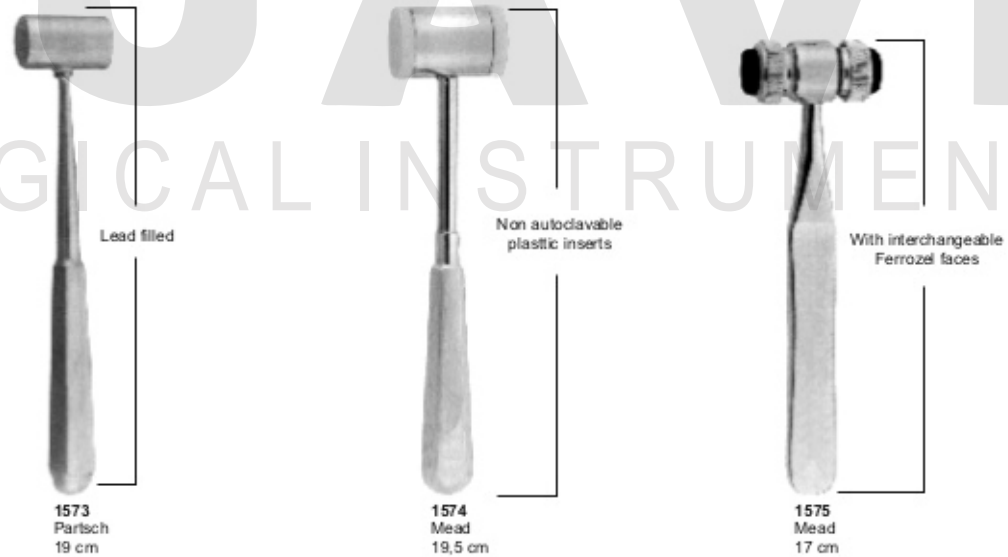



**SUAVE**<sup>®</sup>  
SURGICAL INSTRUMENTS

**Gracey Curettes**

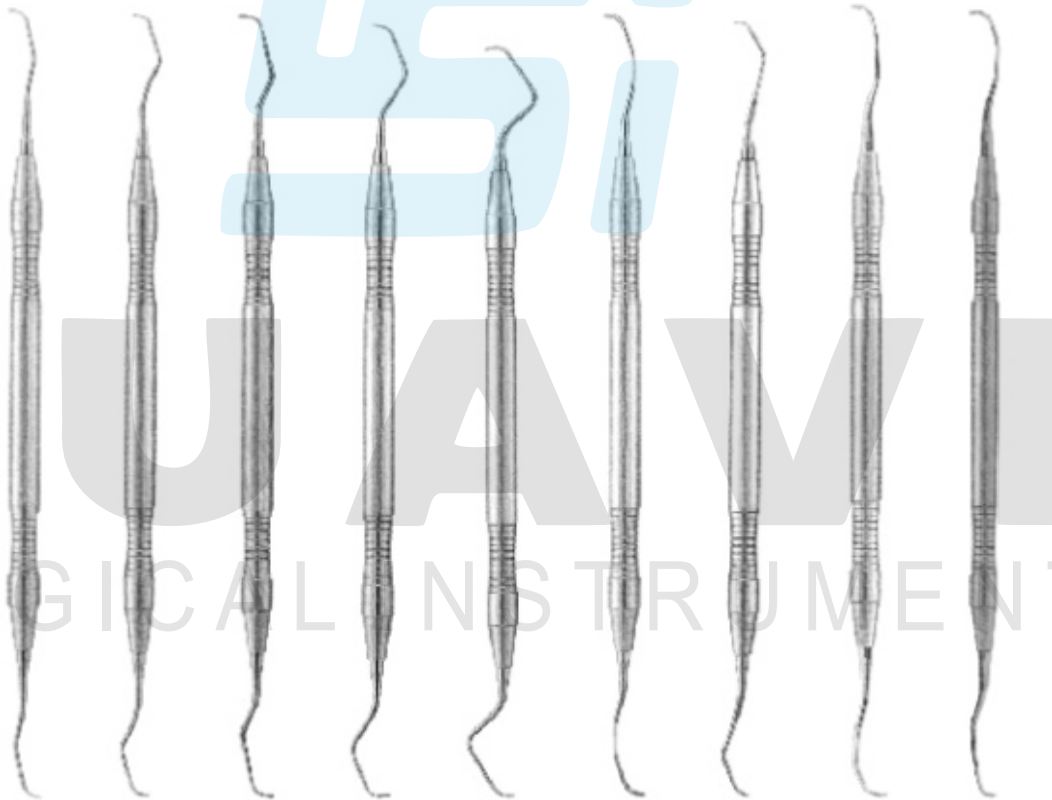
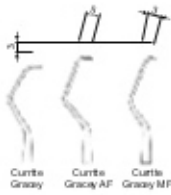

1576  
Gracey  
Fig. 1/2

1577  
Gracey  
Fig. 3/4

1578  
Gracey  
Fig. 5/6

1579  
Gracey  
Fig. 7/8

1580  
Gracey  
Fig. 9/10

1581  
Gracey  
Fig. 11/12

1582  
Gracey  
Fig. 13/14

1583  
Gracey  
Mesial Distal  
Fig. 11/14

1584  
Gracey  
Mesial Distal  
Fig. 12/13



**RASOOL PUR BHALIAN, LALO KAY, SIALKOT - PAKISTAN**

www.suavesurgical.com  
info@suavesurgical.com  
suavesurgical1988@gmail.com





**SUAVE**<sup>®</sup>  
SURGICAL INSTRUMENTS

**Gracey Curettes At type**

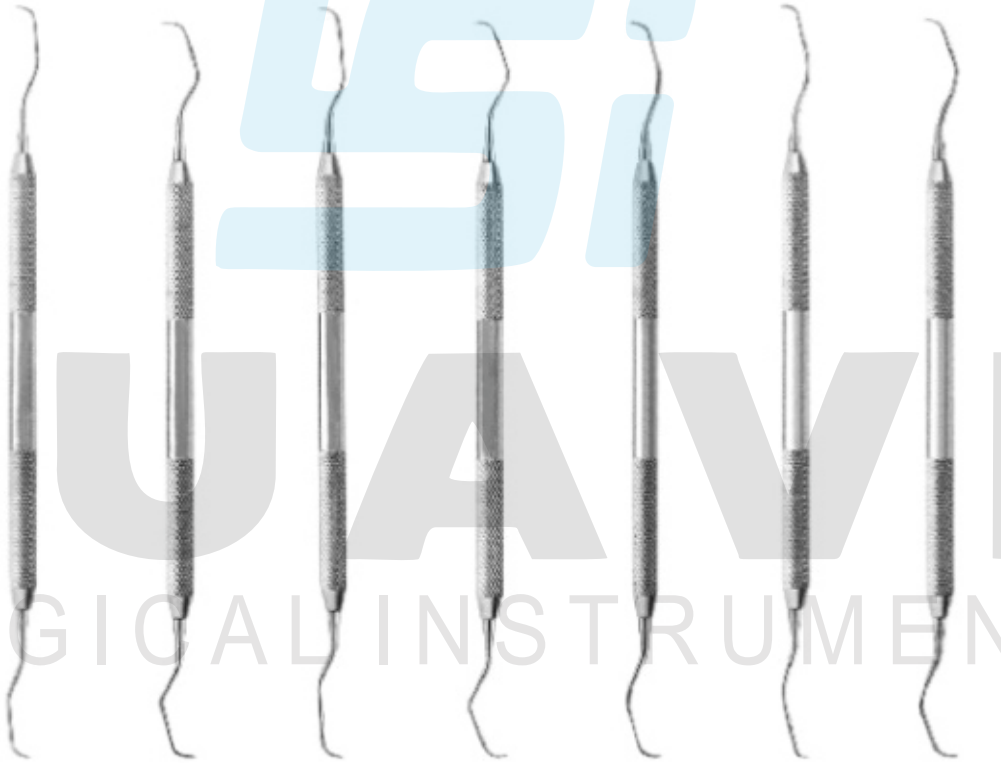
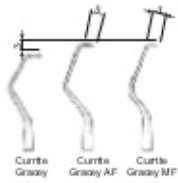

1585  
Gracey  
AF/type  
Fig. 1/2

1586  
Gracey  
AF/type  
Fig. 3/4

1587  
Gracey  
AF/type  
Fig. 5/6

1588  
Gracey  
AF/type  
Fig. 7/8

1589  
Gracey  
AF/type  
Fig. 11/12

1590  
Gracey  
AF/type  
Fig. 13/14

1591  
Gracey  
AF/type  
Fig. 15/16



**RASOOL PUR BHALIAN, LALO KAY, SIALKOT - PAKISTAN**

[www.suavesurgical.com](http://www.suavesurgical.com)  
[info@suavesurgical.com](mailto:info@suavesurgical.com)  
[suavesurgical1988@gmail.com](mailto:suavesurgical1988@gmail.com)

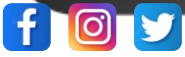

**SUAVE**<sup>®</sup>  
SURGICAL INSTRUMENTS

**Gracey Curettes At "MF" type**



1592  
Gracey  
AF/type



1593  
Gracey  
AF/type  
Fig. 1/2



1594  
Gracey  
AF/type  
Fig. 3/4



1595  
Gracey  
AF/type  
Fig. 5/6



1596  
Gracey  
AF/type  
Fig. 7/8



1597  
Gracey  
AF/type  
Fig. 11/12



1598  
Gracey  
AF/type  
Fig. 13/14



1599  
Gracey  
AF/type  
Fig. 15/16



1600  
Gracey  
MF/type  
Fig. 1/2



1601  
Gracey  
MF/type  
Fig. 3/4



1602  
Gracey  
MF/type  
Fig. 5/6



1603  
Gracey  
MF/type  
Fig. 7/8



1604  
Gracey  
MF/type  
Fig. 11/12



1605  
Gracey  
MF/type  
Fig. 13/14



1606  
Gracey  
MF/type  
Fig. 15/16

SUAVE<sup>®</sup>  
SURGICAL INSTRUMENTS



**RASOOL PUR BHALIAN, LALO KAY, SIALKOT - PAKISTAN**

www.suavesurgical.com  
info@suavesurgical.com  
suavesurgical1988@gmail.com



**SUAVE**<sup>®</sup>  
SURGICAL INSTRUMENTS

**Curettes Gracey At type**

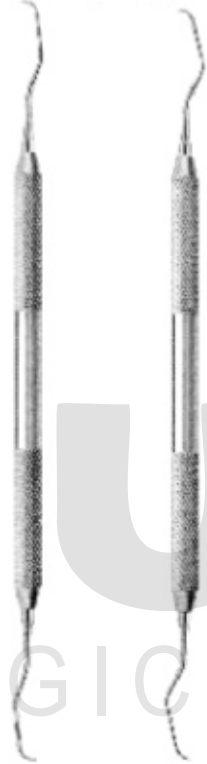
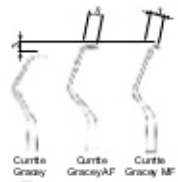

**1607**  
Gracey  
MF/type  
Fig. 1/2

**1608**  
Gracey  
MF/type  
Fig. 3/4

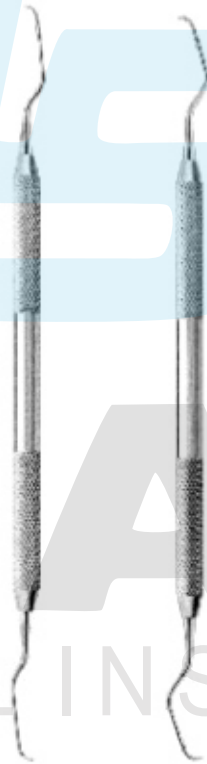

**1609**  
Gracey  
MF/type  
Fig. 5/6

**1610**  
Gracey  
MF/type  
Fig. 7/8

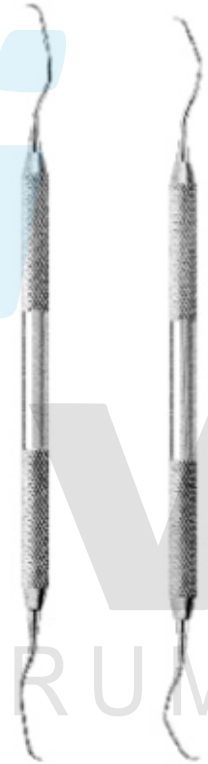

**1611**  
Gracey  
MF/type  
Fig. 11/12

**1612**  
Gracey  
MF/type  
Fig. 13/14



**1613**  
Gracey  
MF/type  
Fig. 15/16



**RASOOL PUR BHALIAN, LALO KAY, SIALKOT - PAKISTAN**

[www.suavesurgical.com](http://www.suavesurgical.com)  
[info@suavesurgical.com](mailto:info@suavesurgical.com)  
[suavesurgical1988@gmail.com](mailto:suavesurgical1988@gmail.com)



**SUAVE**<sup>®</sup>  
SURGICAL INSTRUMENTS

**Curettes and Scalers**

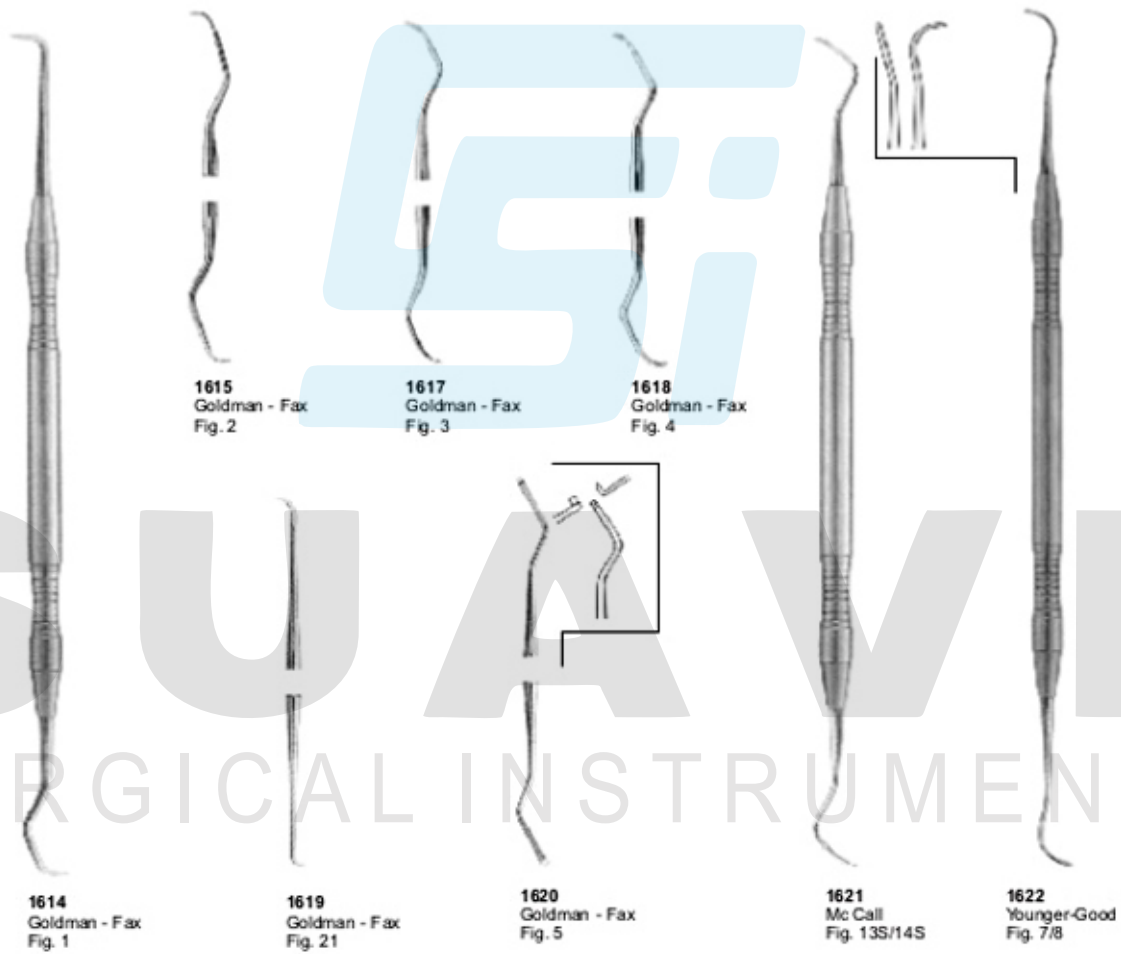

**RASOOL PUR BHALIAN, LALO KAY, SIALKOT - PAKISTAN**

[www.suavesurgical.com](http://www.suavesurgical.com)  
[info@suavesurgical.com](mailto:info@suavesurgical.com)  
[suavesurgical1988@gmail.com](mailto:suavesurgical1988@gmail.com)



**SUAVE**<sup>®</sup>  
SURGICAL INSTRUMENTS

**Curettes and Scalers**

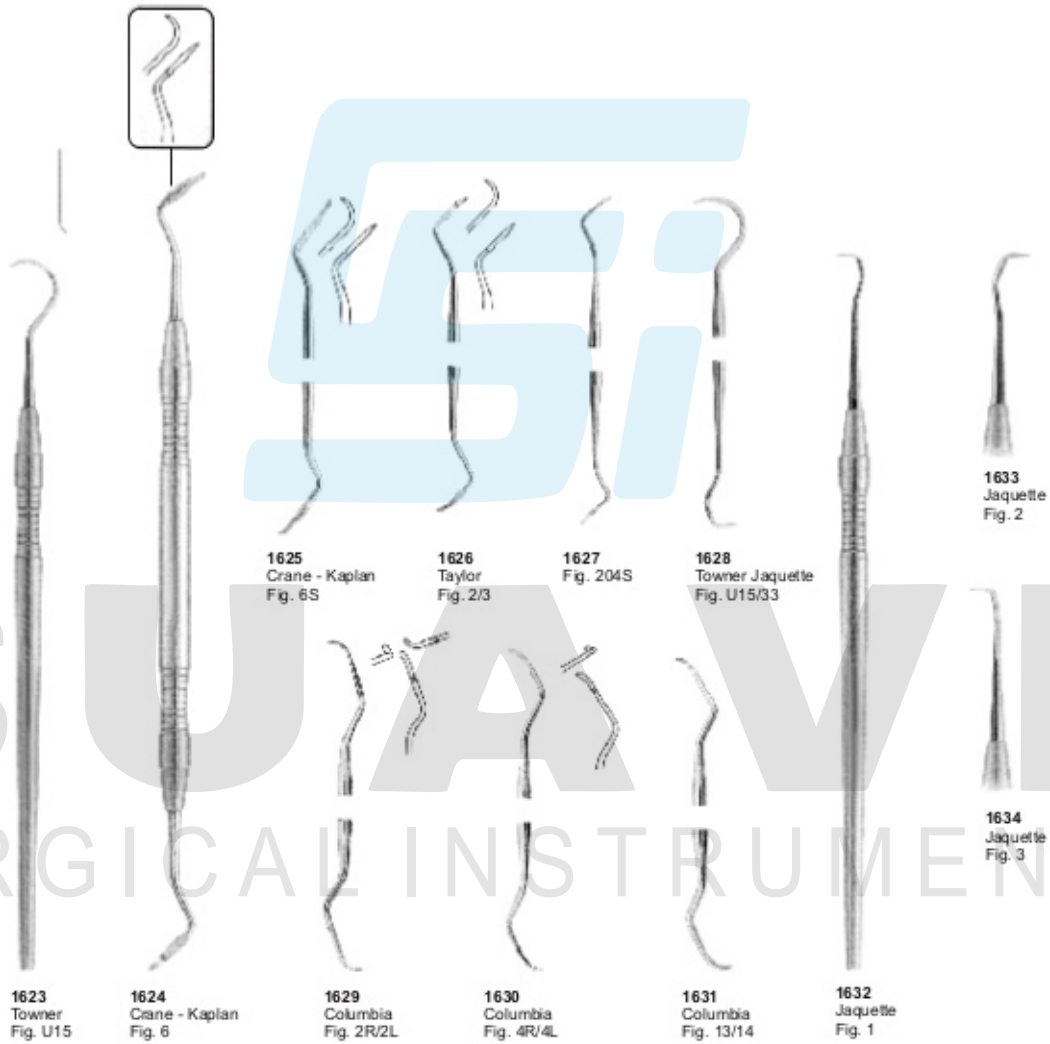

**RASOOL PUR BHALIAN, LALO KAY, SIALKOT - PAKISTAN**

[www.suavesurgical.com](http://www.suavesurgical.com)  
[info@suavesurgical.com](mailto:info@suavesurgical.com)  
[suavesurgical1988@gmail.com](mailto:suavesurgical1988@gmail.com)



**SUAVE**<sup>®</sup>  
SURGICAL INSTRUMENTS

**Bone Curettes**

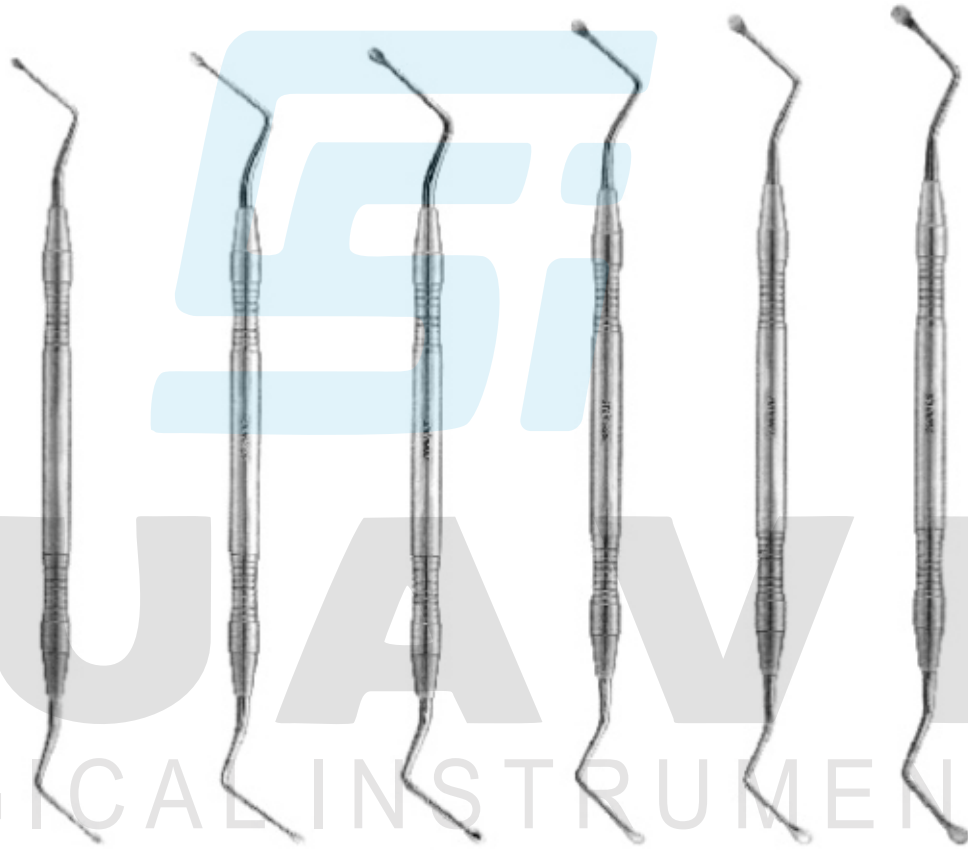

1635  
Hemingway  
Fig. 1

1636  
Hemingway  
Fig. 2

1637  
Hemingway  
Fig. 3

1638  
Lucas  
Fig. 85

1639  
Lucas  
Fig. 86

1640  
Lucas  
Fig. 87



**RASOOL PUR BHALIAN, LALO KAY, SIALKOT - PAKISTAN**

[www.suavesurgical.com](http://www.suavesurgical.com)  
[info@suavesurgical.com](mailto:info@suavesurgical.com)  
[suavesurgical1988@gmail.com](mailto:suavesurgical1988@gmail.com)





**SUAVE**<sup>®</sup>  
SURGICAL INSTRUMENTS

**Modelling instrumetns**

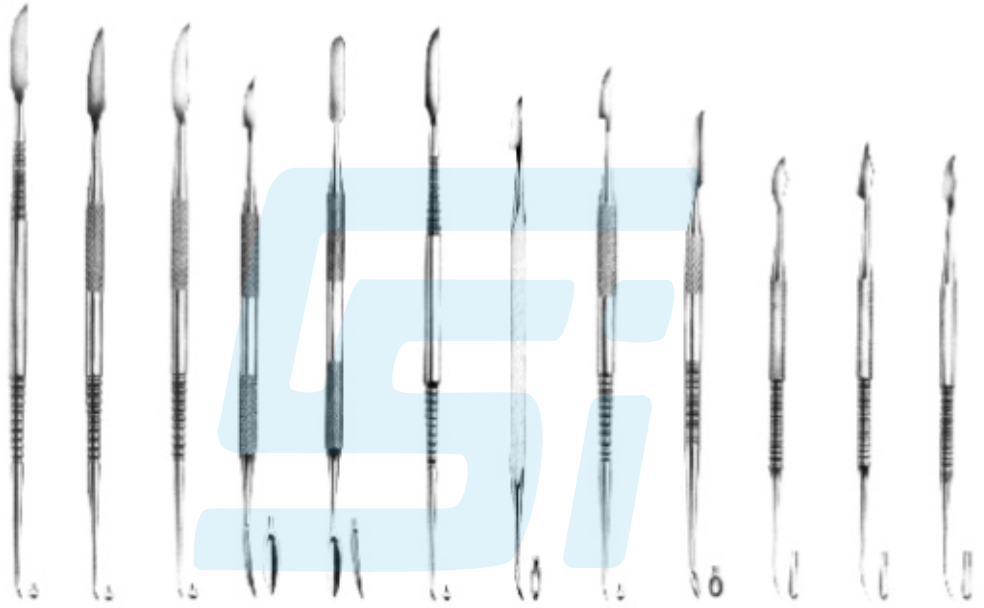

1641 Le Cron 1642 Le Cron 1643 Le Cron 1644 MSY 1645 MSY 1646 Le Cron 1647 Hylin 1648 Hylin 1649 Hylin 1650 Zahle 1651 Zahle 1652 Zahle



1653 Gritman 1654 Beale 1655 Roach 1656 Vehe 1657 P.K. Thomas Fig. 1 1658 P.K. Thomas Fig. 2 1659 P.K. Thomas Fig. 3 1660 P.K. Thomas Fig. 4 1661 P.K. Thomas Fig. 5



**RASOOL PUR BHALIAN, LALO KAY, SIALKOT - PAKISTAN**

[www.suavesurgical.com](http://www.suavesurgical.com)  
[info@suavesurgical.com](mailto:info@suavesurgical.com)  
[suavesurgical1988@gmail.com](mailto:suavesurgical1988@gmail.com)



**SUAVE**<sup>®</sup>  
SURGICAL INSTRUMENTS

**Measuring instruments**



1662  
Boley



1663  
Zuricher  
130 mm



1664  
Vernier  
12 cm



1665  
Vernier



1666  
Caroll



1667  
Castroviejo's  
Scleral Marker



1668  
Wanson



1669  
Albee



**Modelling instrumetns**



**SUAVE**<sup>®</sup>  
SURGICAL INSTRUMENTS



1700  
18 cm  
7 1/8"



1701  
18 cm  
7 1/8"



1702  
17 cm  
6 3/4"  
Griman



1703  
17 cm  
6 3/4"  
Maticon



1704  
22 cm  
8 3/4"



1705  
Ankoviak



1706  
Ermert



1707  
Ermert

SUAVE<sup>®</sup>  
SURGICAL INSTRUMENTS





**SUAVE**<sup>®</sup>  
SURGICAL INSTRUMENTS

**Wax Knives**

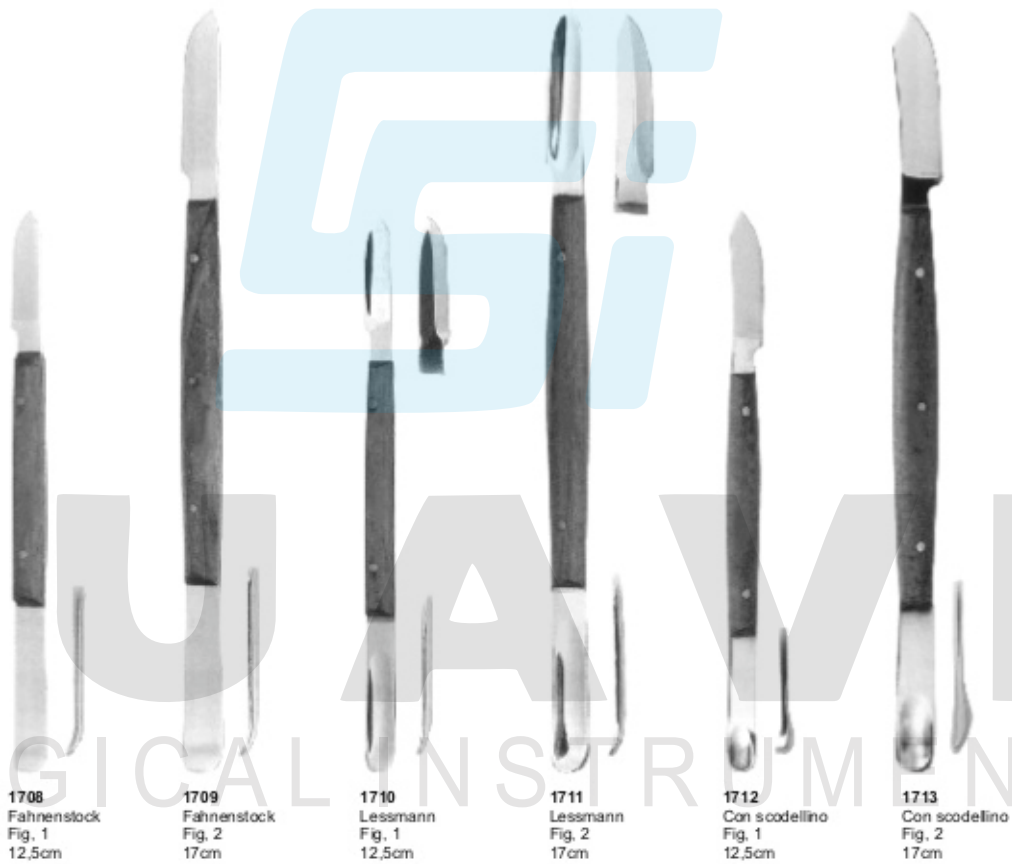

**1708**  
Fahnenstock  
Fig. 1  
12,5cm

**1709**  
Fahnenstock  
Fig. 2  
17cm

**1710**  
Lessmann  
Fig. 1  
12,5cm

**1711**  
Lessmann  
Fig. 2  
17cm

**1712**  
Con scodellino  
Fig. 1  
12,5cm

**1713**  
Con scodellino  
Fig. 2  
17cm



**RASOOL PUR BHALIAN, LALO KAY, SIALKOT - PAKISTAN**

[www.suavesurgical.com](http://www.suavesurgical.com)  
[info@suavesurgical.com](mailto:info@suavesurgical.com)  
[suavesurgical1988@gmail.com](mailto:suavesurgical1988@gmail.com)

**Plaster Knives**



**SUAVE**<sup>®</sup>  
SURGICAL INSTRUMENTS



1714  
Fig. 1  
17 cm



1715  
Giltman  
Fig. 2  
17 cm



1716  
Fig. 3  
16 cm



1717  
Fig. 4  
16 cm



**RASOOL PUR BHALIAN, LALO KAY, SIALKOT - PAKISTAN**

[www.suavesurgical.com](http://www.suavesurgical.com)  
[info@suavesurgical.com](mailto:info@suavesurgical.com)  
[suavesurgical1988@gmail.com](mailto:suavesurgical1988@gmail.com)



**SUAVE**<sup>®</sup>  
SURGICAL INSTRUMENTS

**Diagnostic**

Explorers



1800  
Fig 23



1801  
Fig 6



1802  
Fig 8



1803  
Fig 9



1804  
Fig 17



1805  
Fig 3  
Rein



1806  
Fig 23/17



1807  
Fig 17



**RASOOL PUR BHALIAN, LALO KAY, SIALKOT - PAKISTAN**

www.suavesurgical.com  
info@suavesurgical.com  
suavesurgical1988@gmail.com



**Endodontic instruments**



**SUAVE**<sup>®</sup>  
SURGICAL INSTRUMENTS

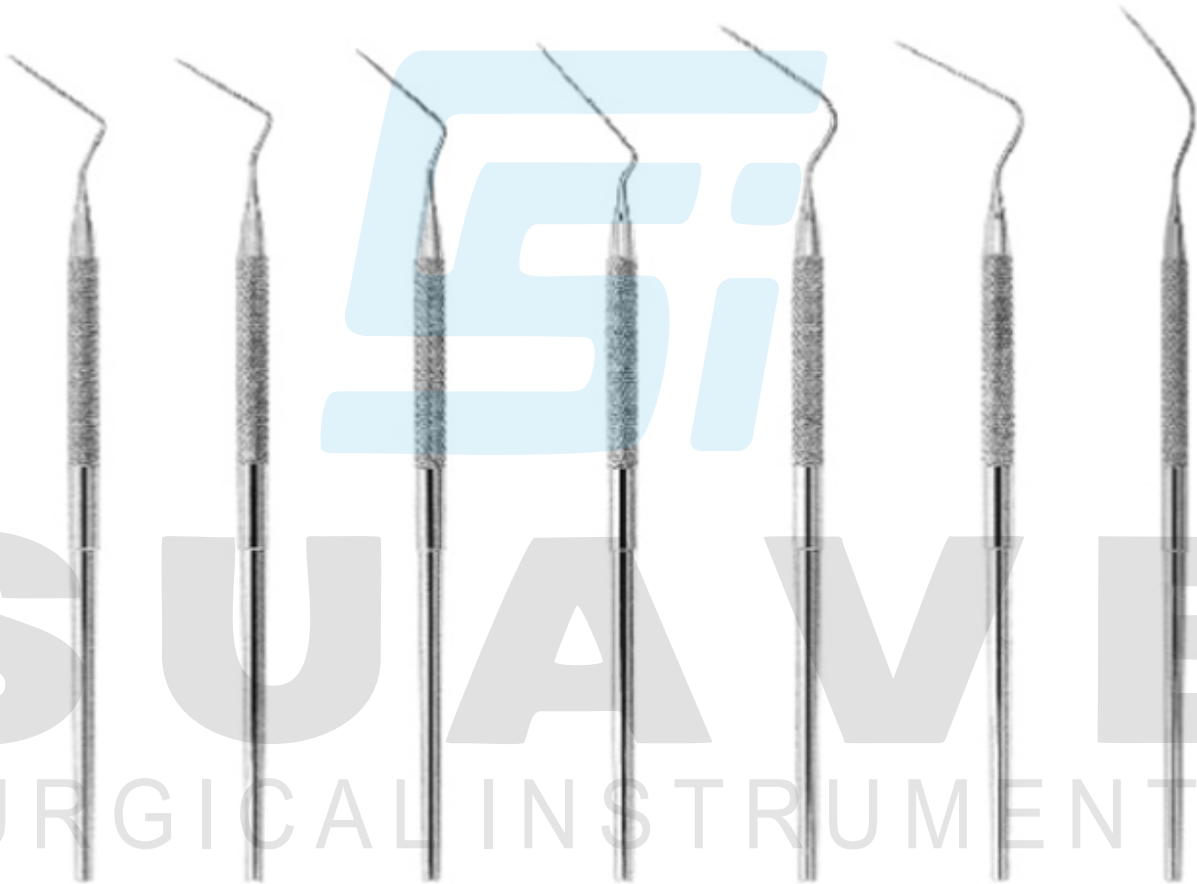

1808  
Fig.1  
Spreader

1809  
Fig.2  
Spreader

1810  
Fig.3  
Spreader

1811  
Fig.4  
Spreader

1812  
Fig.5  
Spreader

1813  
Fig.6  
Spreader

1814  
Fig.7  
Spreader



**RASOOL PUR BHALIAN, LALO KAY, SIALKOT - PAKISTAN**

[www.suavesurgical.com](http://www.suavesurgical.com)  
[info@suavesurgical.com](mailto:info@suavesurgical.com)  
[suavesurgical1988@gmail.com](mailto:suavesurgical1988@gmail.com)



# Endodontic instruments



Double-Ended Root Canal  
Explorers Plugger/Spreaders

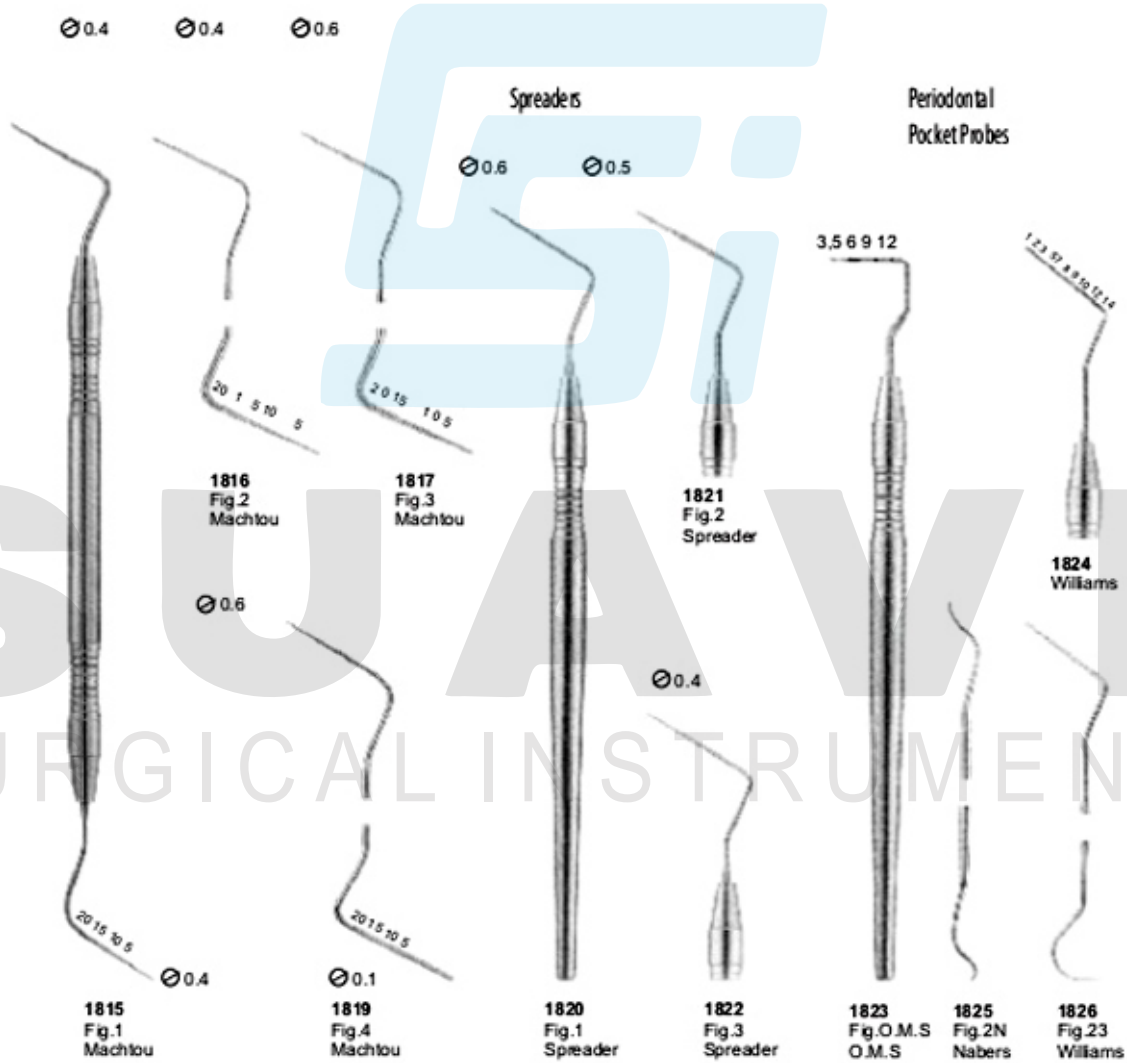

**Endodontic instruments**



Root-canal pluggers

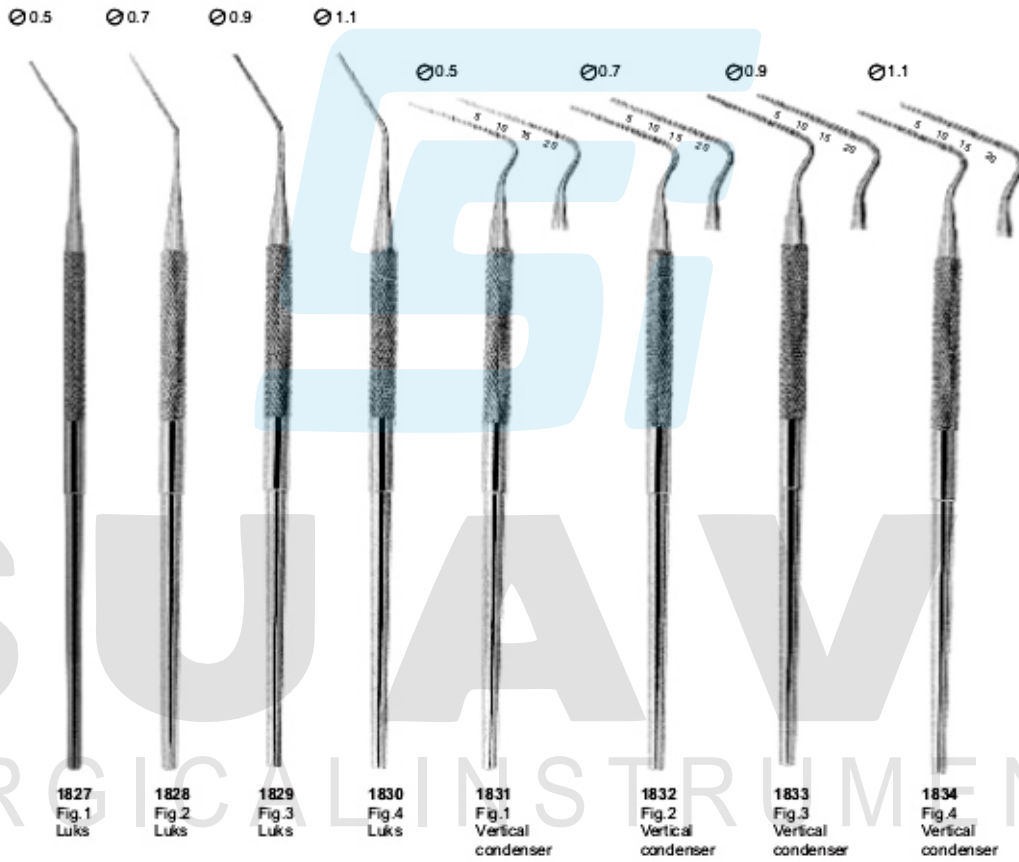

1827  
Fig.1  
Luks

1828  
Fig.2  
Luks

1829  
Fig.3  
LUKS

1830  
Fig.4  
LUKS

1831  
Fig.1  
Vertical  
condenser

1832  
Fig.2  
Vertical  
condenser

1833  
Fig.3  
Vertical  
condenser

1834  
Fig.4  
Vertical  
condenser

Endodontic set

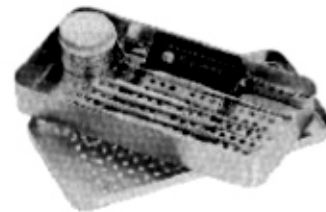

1835  
Measuring Plate



**Endodontic instruments**



Root-canal pluggers

Optimum Flexibility  
Very Fine Points

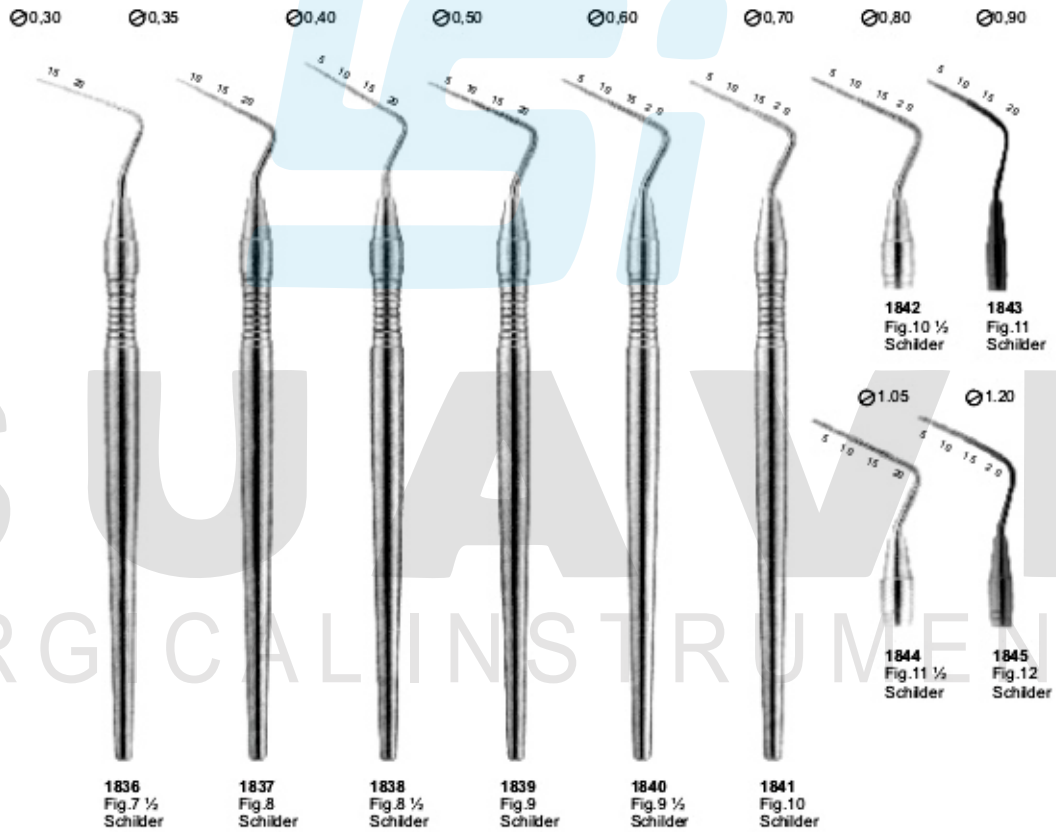



**SUAVE**<sup>®</sup>  
SURGICAL INSTRUMENTS

**Endodontic instruments**

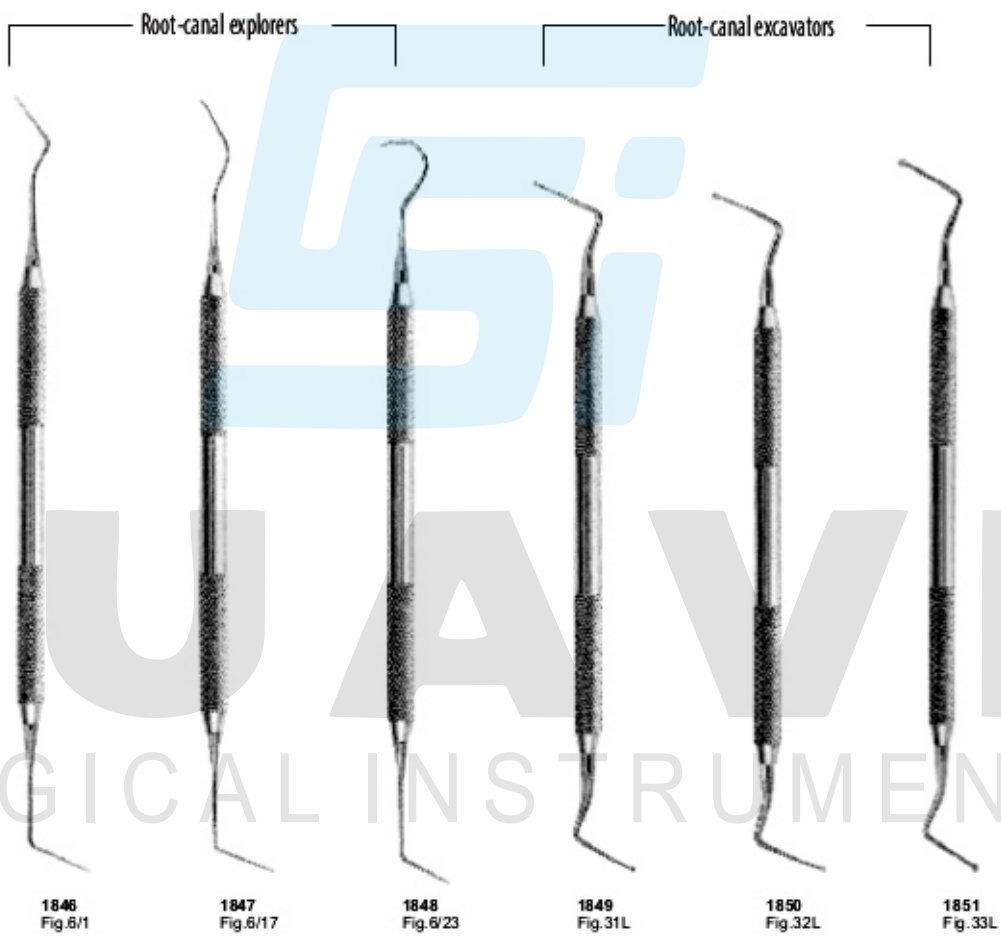

**RASOOL PUR BHALIAN, LALO KAY, SIALKOT - PAKISTAN**

www.suavesurgical.com  
info@suavesurgical.com  
suavesurgical1988@gmail.com



**SUAVE**<sup>®</sup>  
SURGICAL INSTRUMENTS

**Excavators**

1 mm



1852  
Fig 5

1.2 mm



1853  
Fig 14

1 mm



1854  
Fig 17

1.2 mm



1855  
Fig 18

1.6 mm



1856  
Fig 19

2 mm



1857  
Fig 20

SUAVE<sup>®</sup>  
SURGICAL INSTRUMENTS



**RASOOL PUR BHALIAN, LALO KAY, SIALKOT - PAKISTAN**

www.suavesurgical.com  
info@suavesurgical.com  
suavesurgical1988@gmail.com





**SUAVE**<sup>®</sup>  
SURGICAL INSTRUMENTS

**Excavators**

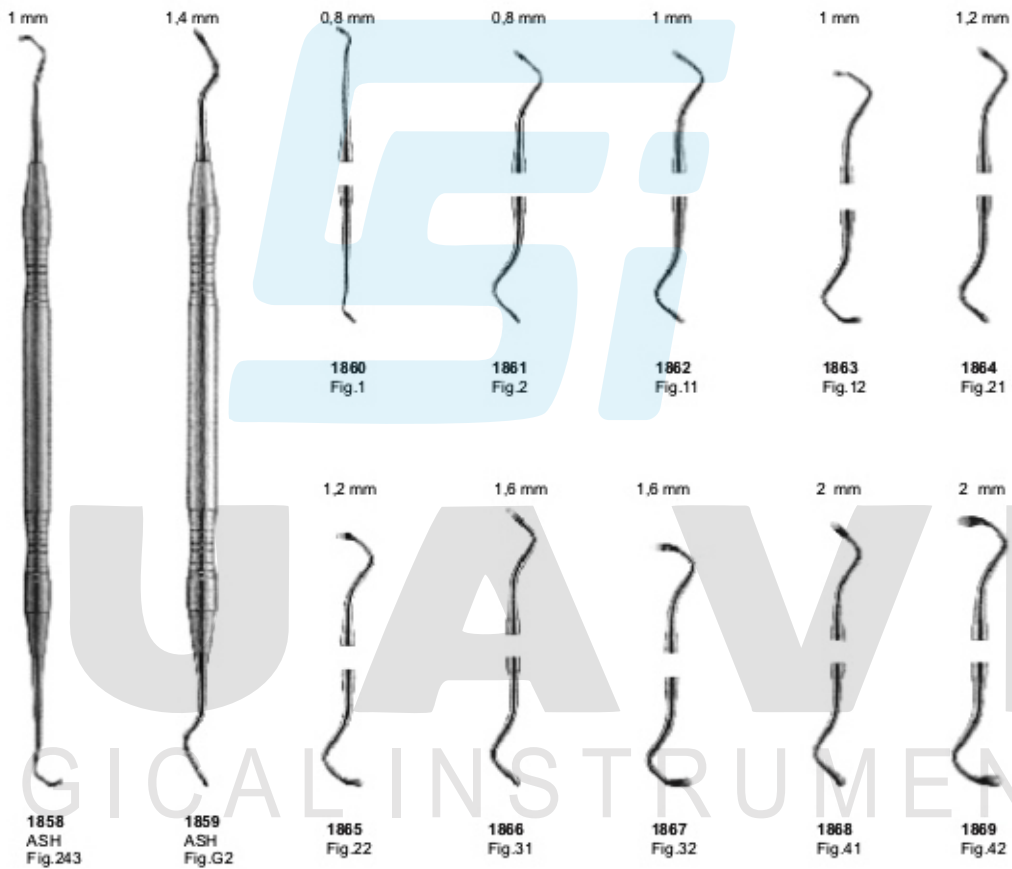



**SUAVE**<sup>®</sup>  
SURGICAL INSTRUMENTS

**Handles for mouth mirrors  
and mouth mirrors**

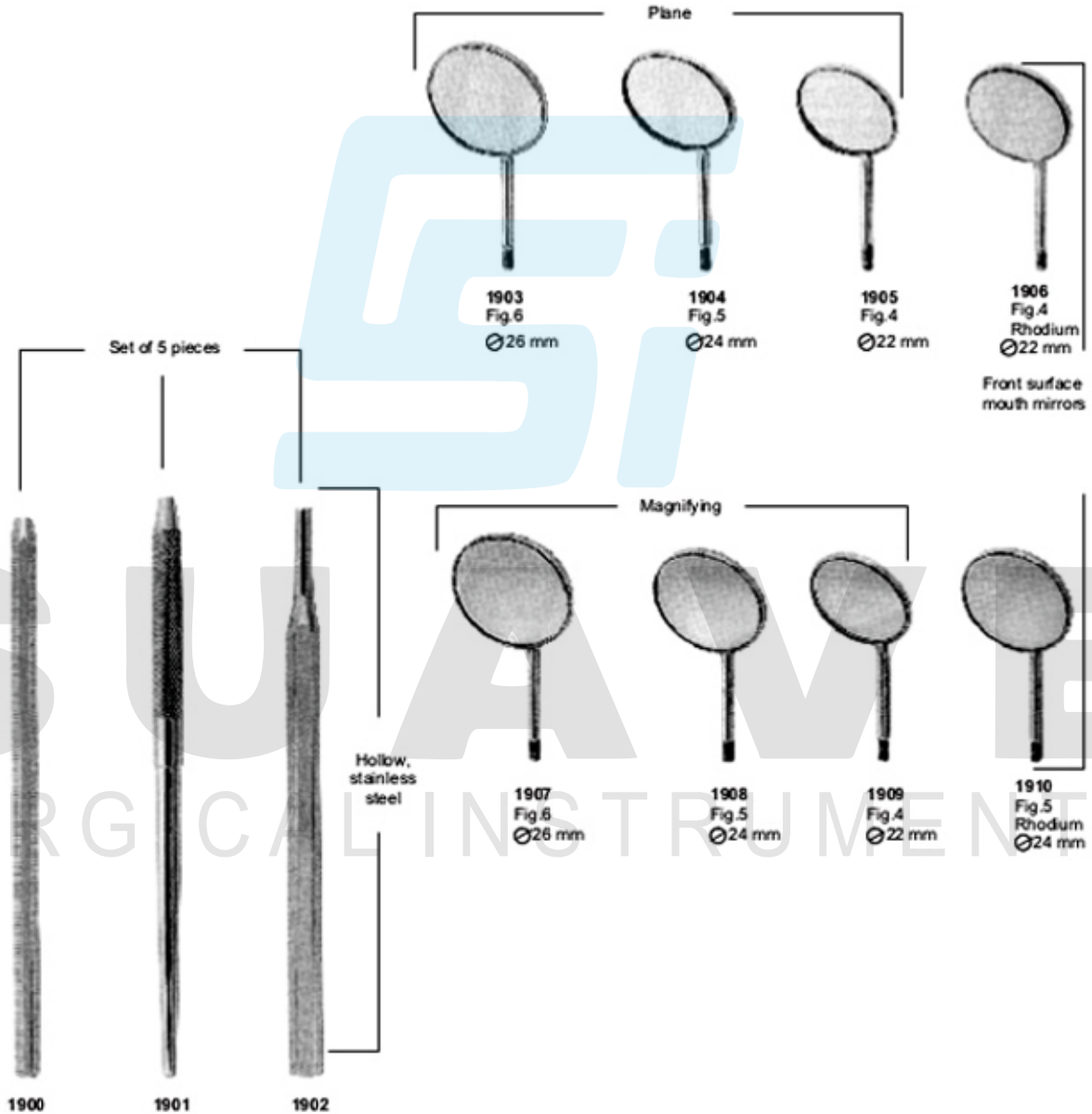

**RASOOL PUR BHALIAN, LALO KAY, SIALKOT - PAKISTAN**

www.suavesurgical.com  
info@suavesurgical.com  
suavesurgical1988@gmail.com



**Handles for mouth mirrors  
and mouth mirrors**



**SUAVE**<sup>®</sup>  
SURGICAL INSTRUMENTS



1911



1912



1913



1914



1915

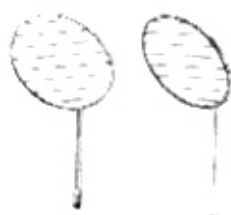

1916  
Parallelometer  
mouth mirror



1917  
Parallelometer  
mouth mirror  
+ handle  
code 2101

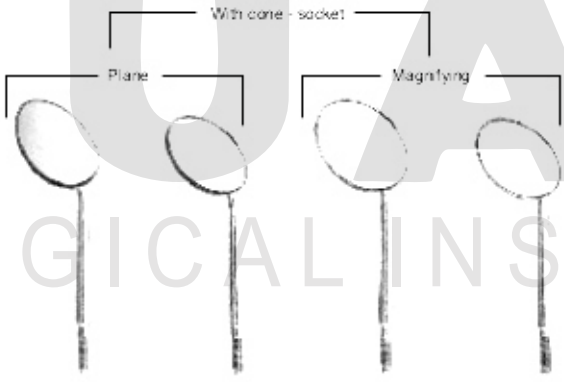
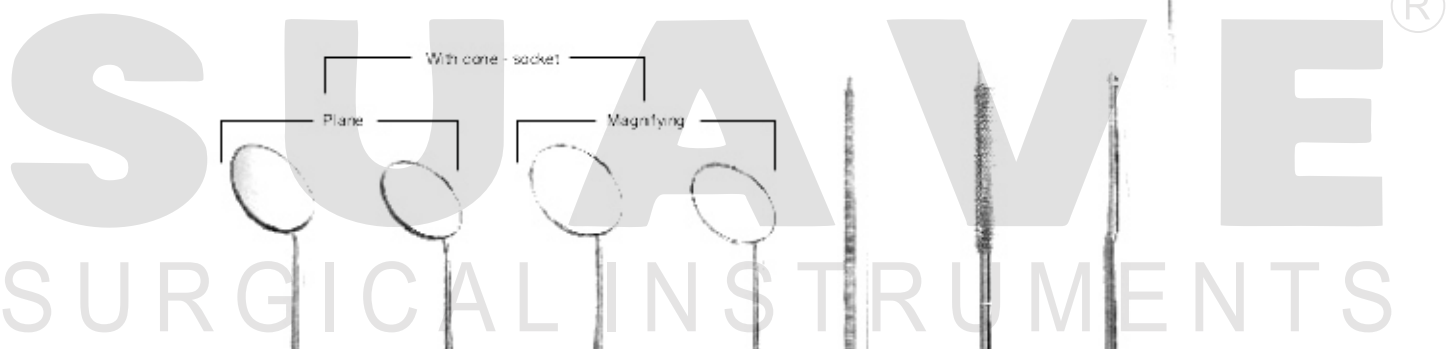

1918  
Fig.5  
Ø 24 mm

1919  
Fig.4  
Ø 22 mm

1920  
Fig.5  
Ø 24 mm

1921  
Fig.4  
Ø 22 mm



1922  
Cane - socket



1923  
Cane - socket



1924  
Cane - socket





**Cement Spatulas**



**SUAVE**<sup>®</sup>  
SURGICAL INSTRUMENTS



2000



2001



2002



2003



2004



2005



2006



2007

**SUAVE**<sup>®</sup>  
SURGICAL INSTRUMENTS



**RASOOL PUR BHALIAN, LALO KAY, SIALKOT - PAKISTAN**

[www.suavesurgical.com](http://www.suavesurgical.com)  
[info@suavesurgical.com](mailto:info@suavesurgical.com)  
[suavesurgical1988@gmail.com](mailto:suavesurgical1988@gmail.com)



**SUAVE**<sup>®</sup>  
SURGICAL INSTRUMENTS

**Cement Spatulas**

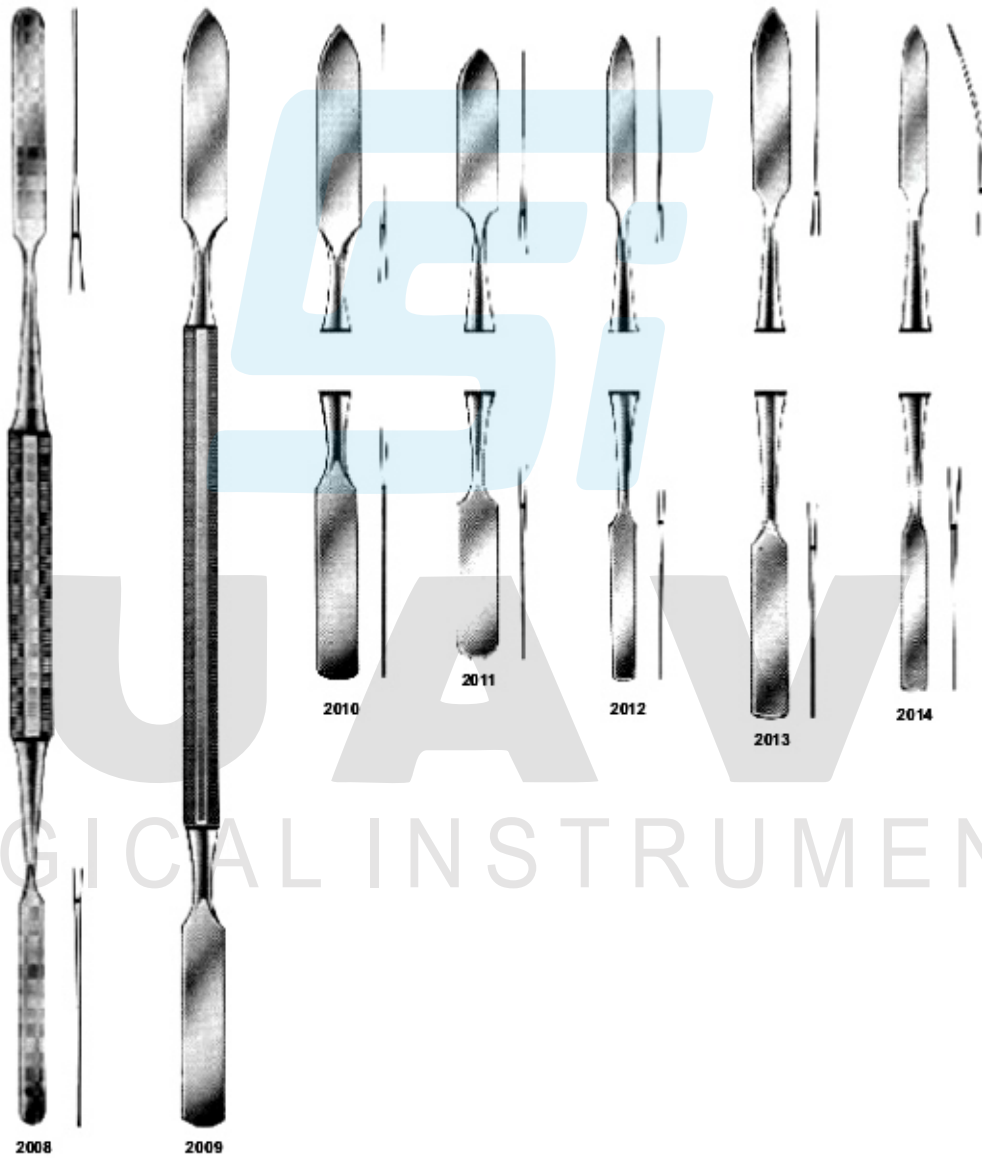

**RASOOL PUR BHALIAN, LALO KAY, SIALKOT - PAKISTAN**

[www.suavesurgical.com](http://www.suavesurgical.com)  
[info@suavesurgical.com](mailto:info@suavesurgical.com)  
[suavesurgical1988@gmail.com](mailto:suavesurgical1988@gmail.com)



**SUAVE**<sup>®</sup>  
SURGICAL INSTRUMENTS

**Spatulas**



**RASOOL PUR BHALIAN, LALO KAY, SIALKOT - PAKISTAN**

[www.suavesurgical.com](http://www.suavesurgical.com)  
[info@suavesurgical.com](mailto:info@suavesurgical.com)  
[suavesurgical1988@gmail.com](mailto:suavesurgical1988@gmail.com)





**SUAVE**<sup>®</sup>  
SURGICAL INSTRUMENTS

**Spatulas**



**RASOOL PUR BHALIAN, LALO KAY, SIALKOT - PAKISTAN**

www.suavesurgical.com  
info@suavesurgical.com  
suavesurgical1988@gmail.com



**SUAVE**<sup>®</sup>  
SURGICAL INSTRUMENTS

**Needle holders & stainless steel**



**SUAVE**<sup>®</sup>  
SURGICAL INSTRUMENTS

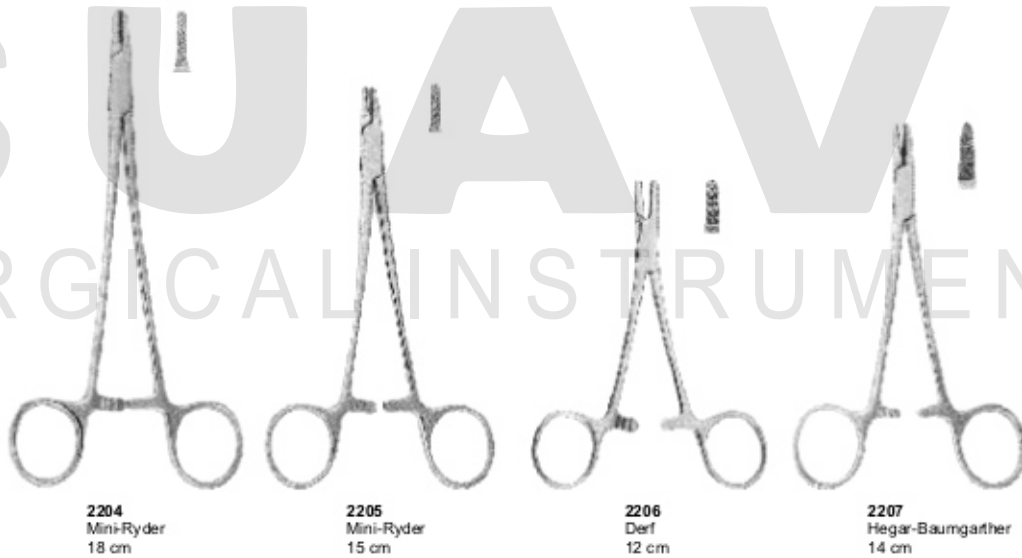

**RASOOL PUR BHALIAN, LALO KAY, SIALKOT - PAKISTAN**

[www.suavesurgical.com](http://www.suavesurgical.com)  
[info@suavesurgical.com](mailto:info@suavesurgical.com)  
[suavesurgical1988@gmail.com](mailto:suavesurgical1988@gmail.com)



**SUAVE**<sup>®</sup>  
SURGICAL INSTRUMENTS

**Needle holders & stainless steel**

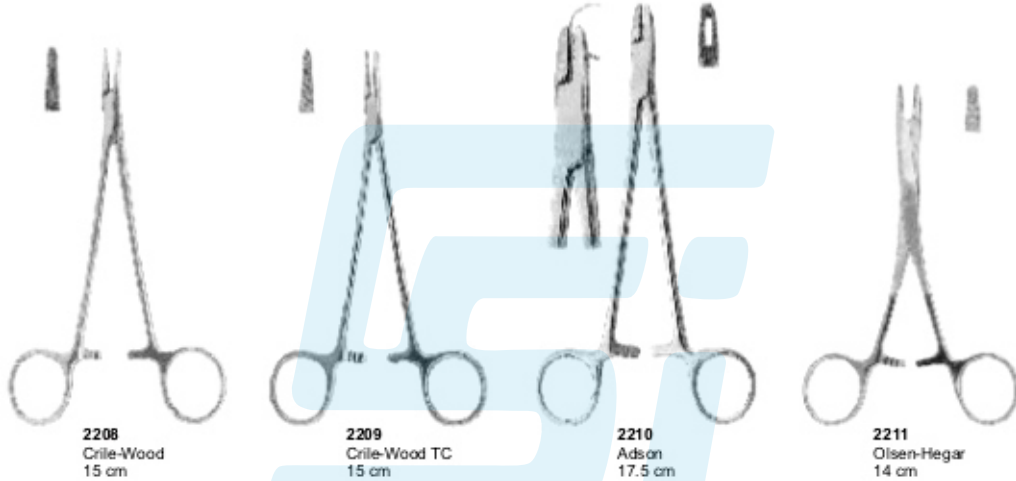

**SUAVE**<sup>®</sup>  
SURGICAL INSTRUMENTS





**SUAVE**<sup>®</sup>  
SURGICAL INSTRUMENTS

**Needle holders & stainless steel**



2216  
Toennis  
18 cm



2217  
Toennis  
18 cm



2218  
Lichtenberg  
17 cm



2219  
Lichtenberg  
17 cm

**SUAVE**<sup>®</sup>  
SURGICAL INSTRUMENTS



2220  
Eisberg-Mathieu  
19.5 cm



2221  
Boynton  
12 cm



2222  
Arruga  
16 cm



2223  
Boynton  
12 cm



2224  
Arruga  
16 cm





**SUAVE**<sup>®</sup>  
SURGICAL INSTRUMENTS

**Needle holders & stainless steel**



**2225**  
Castroviejo  
14 cm



**2226**  
Castroviejo  
14 cm



**2227**  
Castroviejo  
14/60 cm



**2228**  
Castroviejo  
18 cm



**2229**  
Castroviejo  
18 cm



**2230**  
Castroviejo  
14 cm



**2231**  
Castroviejo  
14 cm



**2232**  
Castroviejo  
14/60 cm



**2233**  
Castroviejo  
18 cm

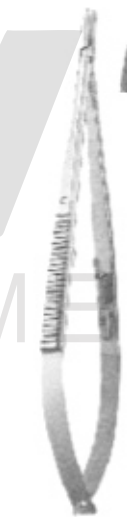

**2234**  
Castroviejo  
18 cm

**SUAVE**<sup>®</sup>  
SURGICAL INSTRUMENTS



**RASOOL PUR BHALIAN, LALO KAY, SIALKOT - PAKISTAN**

[www.suavesurgical.com](http://www.suavesurgical.com)  
[info@suavesurgical.com](mailto:info@suavesurgical.com)  
[suavesurgical1988@gmail.com](mailto:suavesurgical1988@gmail.com)



**SUAVE**<sup>®</sup>  
SURGICAL INSTRUMENTS

**Needle holders & stainless steel**



2235  
Mathieu  
14 cm



2236  
Mathieu  
14 cm



2237  
Mathieu  
14 cm



2238  
Mathieu  
14 cm



2239  
Mathieu  
17 cm



2240  
Mathieu  
17 cm



2241  
Mathieu  
14 cm



2242  
Micro-Barraquer  
18 cm



**RASOOL PUR BHALIAN, LALO KAY, SIALKOT - PAKISTAN**

[www.suavesurgical.com](http://www.suavesurgical.com)  
[info@suavesurgical.com](mailto:info@suavesurgical.com)  
[suavesurgical1988@gmail.com](mailto:suavesurgical1988@gmail.com)





**SUAVE**<sup>®</sup>  
SURGICAL INSTRUMENTS

**Needle holders & stainless steel**



The tips have tungsten carbide inserts for better handling.



2243  
Mathieu  
17 cm



2244  
Mathieu  
17 cm

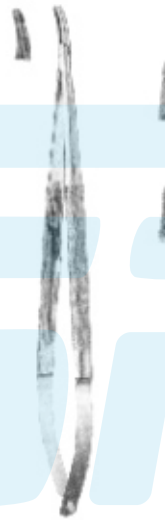

2245  
Micro-Barraquer  
14 cm



2246  
Castroviejo  
13 cm



2247  
Castroviejo-Barraquer  
13 cm



2248  
Castroviejo  
13 cm



2249  
Castroviejo  
13 cm

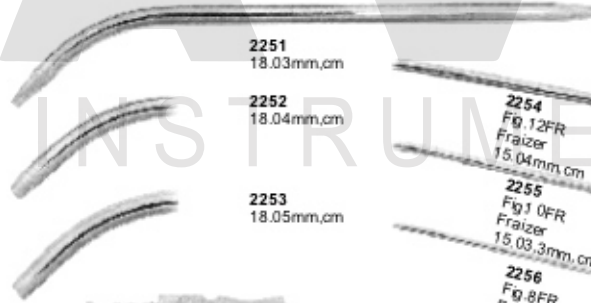

2251  
18.03mm,cm

2252  
18.04mm,cm

2253  
18.05mm,cm

2254  
Fig. 12FR  
Fraizer  
15.04mm,cm

2255  
Fig. J OFR  
Fraizer  
15.03,3mm,cm

2256  
Fig. 8FR  
Fraizer  
15.02,7mm,cm

2250  
Fig. 6FR  
Fraizer  
15.02mm,cm





**WATER syringe**



**SUAVE**<sup>®</sup>  
SURGICAL INSTRUMENTS



**2303**  
Sparrel Barrel with  
plunger suitable for  
syringes



**2300**  
Water Syringe complete with  
1 cannula (Lure-Lock)

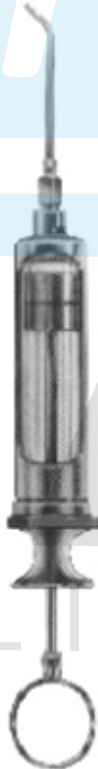

**2301**  
Water Syringe complete with  
1 cannula (Lure-Lock)



**2302**  
Metal water syringe, self-filling,  
with 1 cannula (Lure-Lock)



**2304**  
Cannula, only, with  
Luer-Lock connector  
suitable for syringes





**SUAVE**<sup>®</sup>  
SURGICAL INSTRUMENTS

Syringes'Rulers, Band Adaptor, Position Gauge



2305  
Aspirating Syringe

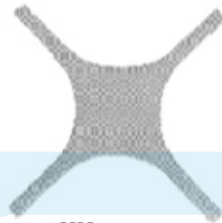

2306  
Position Gauge

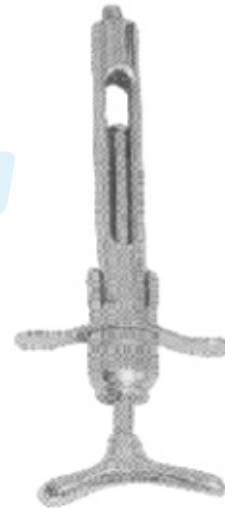

2307  
Breech Loading Syringe

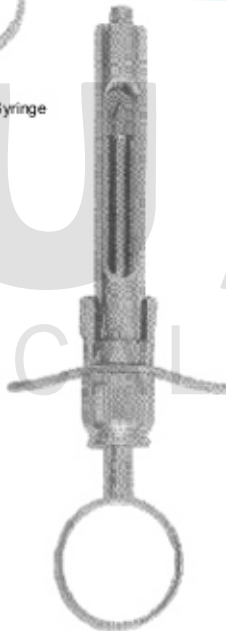

2308  
Aspirating & Breech Syringe



2309  
Band Adaptor



2310  
Endo Finger Ruler  
With Adjustable Slide

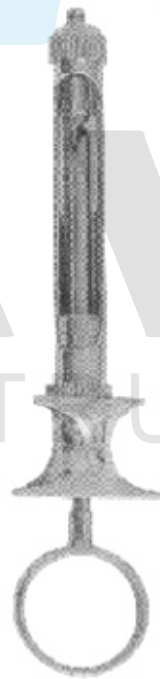

2311  
Aspirating Syringe



**RASOOL PUR BHALIAN, LALO KAY, SIALKOT - PAKISTAN**

www.suavesurgical.com  
info@suavesurgical.com  
suavesurgical1988@gmail.com



**SUAVE**<sup>®</sup>  
SURGICAL INSTRUMENTS

Syringes'Rulers, Band Adaptor, Position Gauge



2312

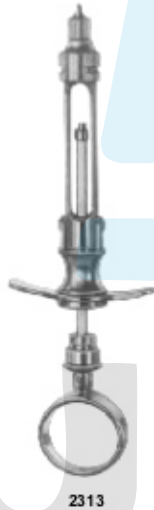

2313



2314



2317  
Tip Only, short



2319



2318  
Tip Only, long

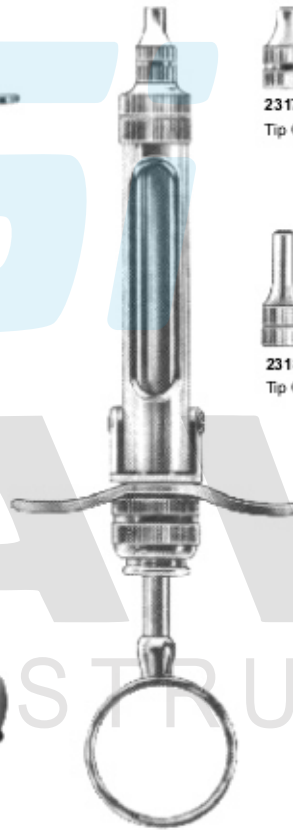

2315 1.8 ml  
2316 2.2 ml

Cartridge Syringe complete  
With 2 lips and without needles



2320



2321



**RASOOL PUR BHALIAN, LALO KAY, SIALKOT - PAKISTAN**

[www.suavesurgical.com](http://www.suavesurgical.com)  
[info@suavesurgical.com](mailto:info@suavesurgical.com)  
[suavesurgical1988@gmail.com](mailto:suavesurgical1988@gmail.com)



**SUAVE**<sup>®</sup>  
SURGICAL INSTRUMENTS

**Intra- Ligamental Syringe & Dental Syringe**



2322  
Cork screw tip



2323  
Cork screw tip



2324  
Folding type, cork  
screw tip



2325  
Folding type, cork  
screw tip



2326



2327  
Cork screw tip



2328  
Spare cap with  
metric thread



2329  
With Whitworth  
thread

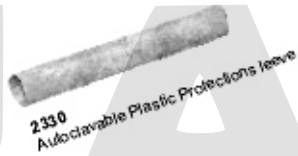

2330

Autoclavable Plastic Protection leave



2331  
Brass syringe with stainless steel moving parts

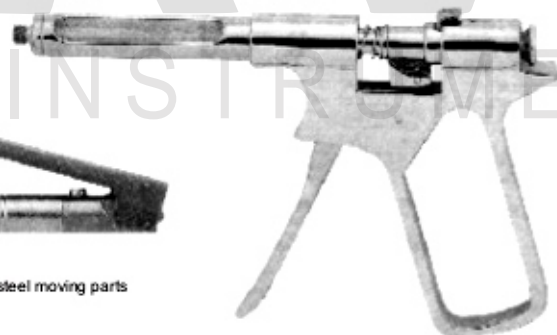

2332  
Brass syringe with stainless  
steel moving parts





**SUAVE**<sup>®</sup>  
SURGICAL INSTRUMENTS

**Dental tweezers**

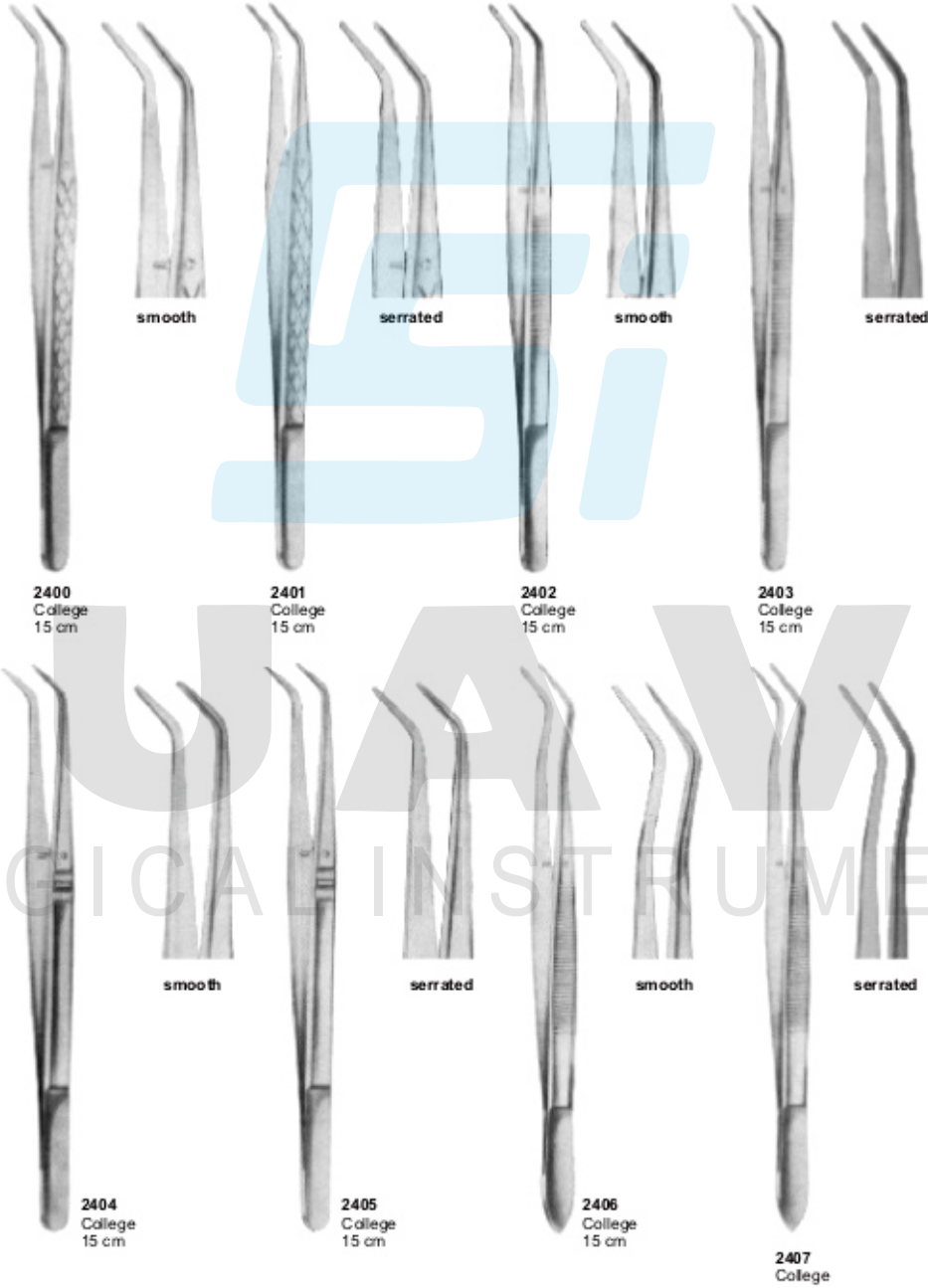

**RASOOL PUR BHALIAN, LALO KAY, SIALKOT - PAKISTAN**

www.suavesurgical.com  
info@suavesurgical.com  
suavesurgical1988@gmail.com



**SUAVE**<sup>®</sup>  
SURGICAL INSTRUMENTS

**Dental tweezers**

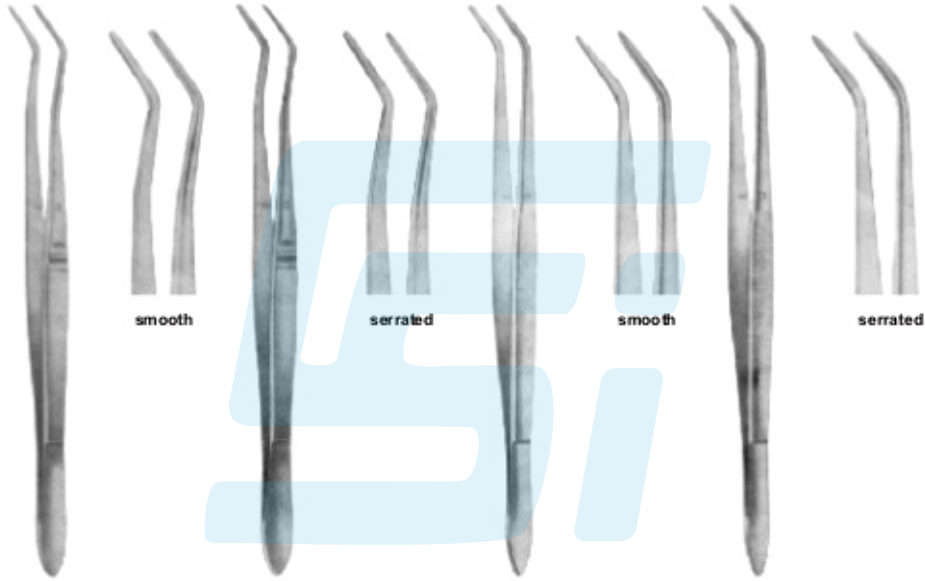

2408  
Meriam  
16 cm

smooth

2409  
Meriam  
16 cm

serrated

2410  
Meriam  
16 cm

smooth

2411  
Meriam  
16 cm

serrated

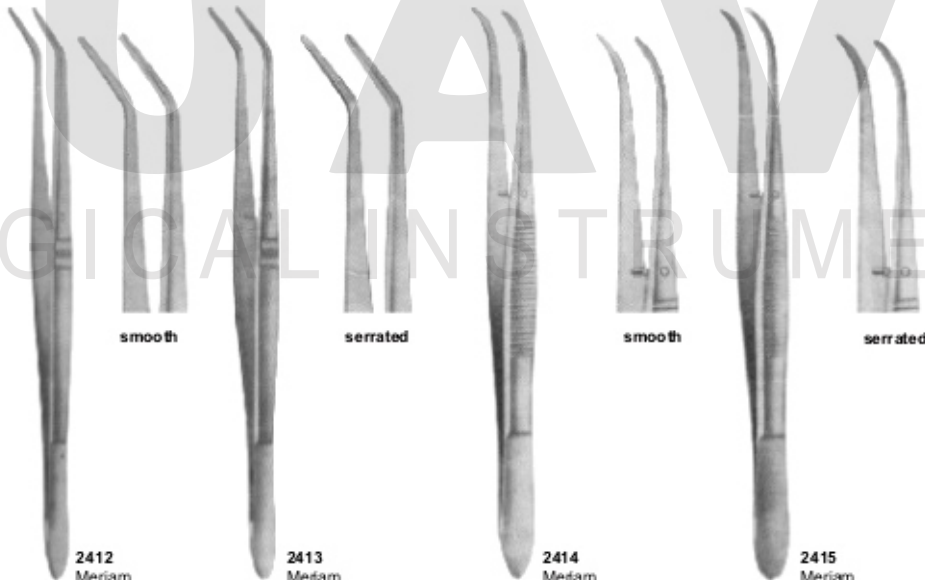

2412  
Meriam  
16 cm

smooth

2413  
Meriam  
16 cm

serrated

2414  
Meriam  
16 cm

smooth

2415  
Meriam  
16 cm

serrated







**SUAVE**<sup>®</sup>  
SURGICAL INSTRUMENTS

**Dental tweezers**

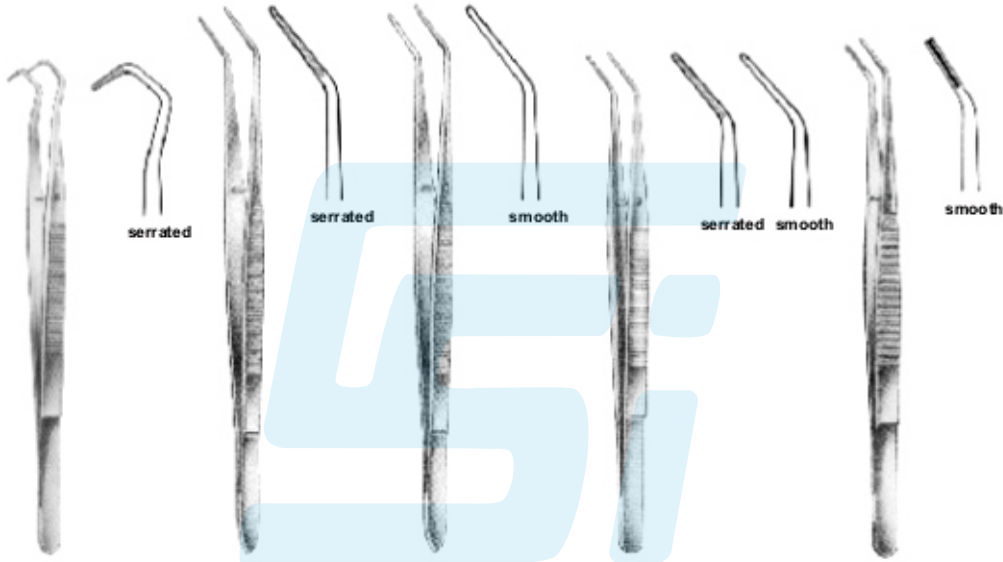

**2416**  
College  
14.5 cm, 5 3/4"

serrated

**2417**  
Flagg  
16 cm, 6 1/4"

serrated

smooth

**2418**  
Flagg  
16 cm, 6 1/4"

serrated smooth

**2419**  
Landgraf  
15 cm, 6"

smooth

**2420**  
15.5 cm, 6 1/8"



**2421**  
15.5 cm, 6 1/8"

con cierre

**2422**  
London-College  
15 cm, 6"

serrated

smooth

**2423**  
London-College  
15 cm, 6"

serrated

smooth

**2424**  
London-College  
15 cm, 6"

**2425**  
London-College  
15 cm, 6"



**RASOOL PUR BHALIAN, LALO KAY, SIALKOT - PAKISTAN**

[www.suavesurgical.com](http://www.suavesurgical.com)  
[info@suavesurgical.com](mailto:info@suavesurgical.com)  
[suavesurgical1988@gmail.com](mailto:suavesurgical1988@gmail.com)





**SUAVE**<sup>®</sup>  
SURGICAL INSTRUMENTS

**Dental tweezers**



2426  
CK1  
15 cm, 6"

2427  
CK2  
15 cm, 6"

2428  
GF2  
16 cm, 6 1/4"

2429  
G11  
16 cm, 6 1/4"

2430  
Kopp  
15.5 cm, 6 1/8"

SUAVE<sup>®</sup>  
SURGICAL INSTRUMENTS



2431  
Kopp  
15.5 cm, 6 1/8"

2432  
Kopp  
15 cm, 6"

2433  
Kopp  
16.5 cm, 6 1/2"

2434  
Kopp  
15.5 cm, 6 1/8"

2435  
Kopp  
15.5 cm, 6 1/8"



**RASOOL PUR BHALIAN, LALO KAY, SIALKOT - PAKISTAN**

[www.suavesurgical.com](http://www.suavesurgical.com)  
[info@suavesurgical.com](mailto:info@suavesurgical.com)  
[suavesurgical1988@gmail.com](mailto:suavesurgical1988@gmail.com)

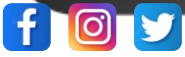

**SUAVE**<sup>®</sup>  
SURGICAL INSTRUMENTS

**Dental tweezers**

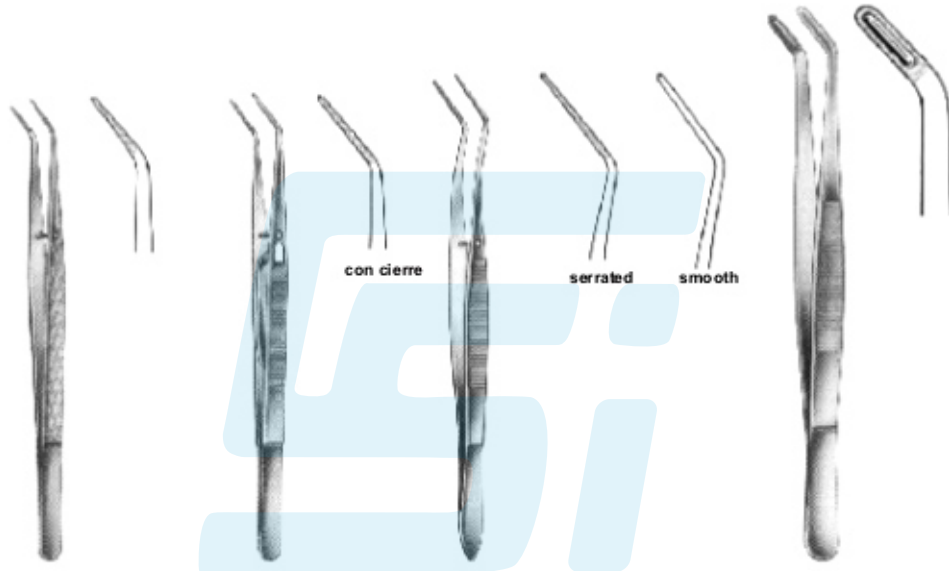

**2436**  
London-College  
15 cm, 6"

**2437**  
London-College  
15 cm, 6"

**2438**  
Meriam  
16 cm, 6 1/4"

**2439**  
Allen  
18 cm, 7 1/8"



**2440**  
Albrecht  
16 cm, 6 1/4"

**2441**  
Albrecht  
16 cm, 6 1/4"

**2442**  
16 cm, 6 1/4"

**2443**  
16 cm, 6 1/4"

**2444**  
16 cm, 6 1/4"



**RASOOL PUR BHALIAN, LALO KAY, SIALKOT - PAKISTAN**

[www.suavesurgical.com](http://www.suavesurgical.com)  
[info@suavesurgical.com](mailto:info@suavesurgical.com)  
[suavesurgical1988@gmail.com](mailto:suavesurgical1988@gmail.com)



**SUAVE**<sup>®</sup>  
SURGICAL INSTRUMENTS

**Rubber Dam Clam Forceps**

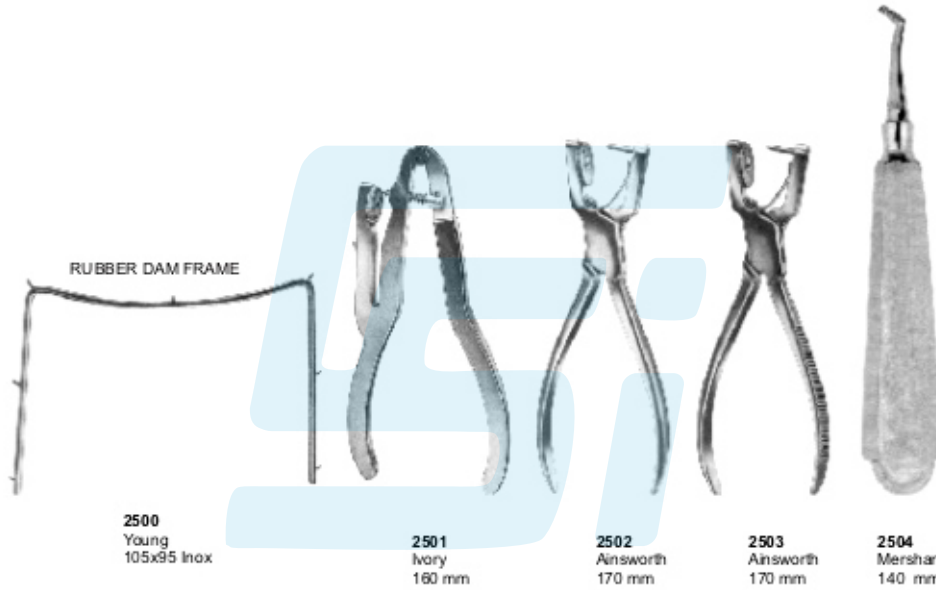

**CLAMPS ( PLIERS )**

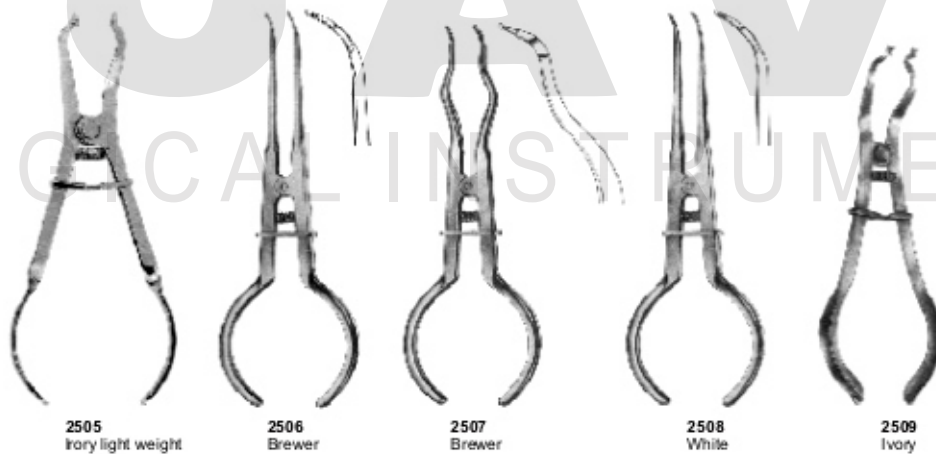



**SUAVE**<sup>®</sup>  
SURGICAL INSTRUMENTS

## Rubber Dam Clams

Anterior



2510 - 9  
Winged  
Labial Clamp



2511 - 9T  
Winged  
Edged Labial Clamp



2512 - 212  
Winged  
Cervical Clamp



2513 - 210  
Winged  
Labial Clamp

Premolars



2514 - 00  
Winged



2515 - 0  
Winged



2516 - W0  
Wingless

For Small Teeth, Elongated or With Narrow Collars



2517 - 1  
Winged



2518 - 1T  
Winged



2519 - W1  
Wingless

For General Use With Adjustable Jaws According  
To Gingival Line Shapes



2520 - 2A  
Winged



2521 - 2AT  
Edged, Winged



2522 - W2A  
Wingless

For Premolars, With Elongated Collar



2523 - 2  
Winged



2524 - 2T  
Edged, Winged



2525 - W2  
Wingless

For Premolars, With Elongated Collar



2526 - 29  
Wingless



2527 - 60  
Wingless



**RASOOL PUR BHALIAN, LALO KAY, SIALKOT - PAKISTAN**

www.suavesurgical.com  
info@suavesurgical.com  
suavesurgical1988@gmail.com



**SUAVE**<sup>®</sup>  
SURGICAL INSTRUMENTS

**Rubber Dam Clams**



2528 - 3  
Winged



2529 - W3  
Wingless



2530 - 4  
Winged



2531 - W4  
Wingless



For Small Lower Molars

For Small Lower Molars With Round clamps



2532 - 7  
Winged



2533 - W7  
Wingless



2534 - 8  
Winged



2535 - W8  
Wingless

For Square Lower Molars

For Round Upper Molars



2536 - 8A  
Winged



2537 - W8A  
Wingless



2538 - 12A  
Winged



2539 - 13A  
Wingless

For Molar Roots

For Partially Broken Molars



2540 - 14  
Winged



2541 - 14T  
Edged Winged



2542 - W14  
Wingless



2543 - 14A  
Winged



2544 - W14A  
Wingless

For Round Molars, Partially Broken, Undersized or Inclined



2545 - 26  
Wingless



2246 - 51  
Wingless



2547 - 202  
Winged



2548 - 205  
Winged



**RASOOL PUR BHALIAN, LALO KAY, SIALKOT - PAKISTAN**

www.suavesurgical.com  
info@suavesurgical.com  
suavesurgical1988@gmail.com



**SUAVE**<sup>®</sup>  
SURGICAL INSTRUMENTS

**Matrix Retainers And Matrix Bands**



2600  
Ivory  
63mm



2601-1  
Toffemire-Universal



2602-2  
Toffemire-Junior



2603-3  
Toffemire-Senior



2604-5  
Ivory 8  
5 mm



2605-6  
Ivory 8  
6 mm



2606  
Ivory 8  
7 mm



2607  
Ivory 8 N



2608  
Dider 8 P



2610-7



2611-8



2612-9



2613-10



2614-11



2615-12



2616-13

1750-5 mm x 100 cm  
1750-6 mm x 100 cm  
1750-7 mm x 100 cm



2609

For Molars and Premolars



**RASOOL PUR BHALIAN, LALO KAY, SIALKOT - PAKISTAN**

www.suavesurgical.com  
info@suavesurgical.com  
suavesurgical1988@gmail.com





**Matrix Bands**

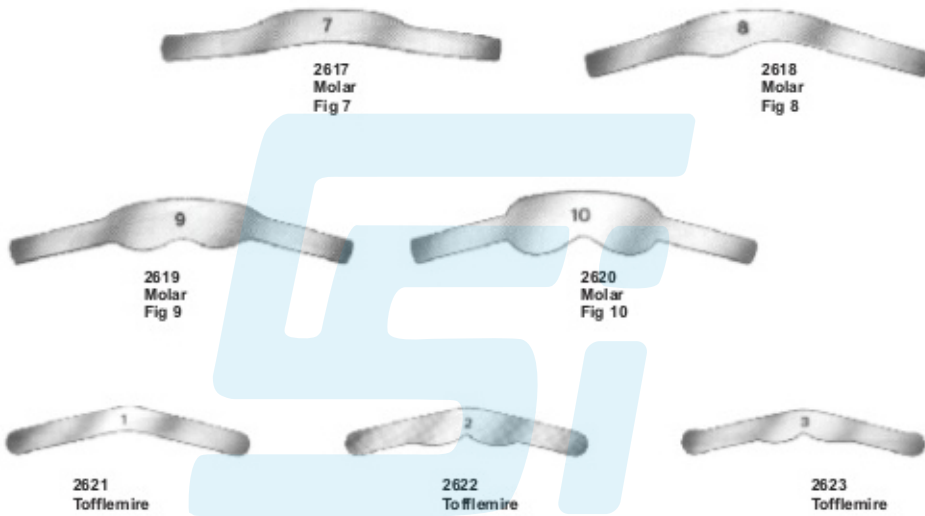





**SUAVE**<sup>®</sup>  
SURGICAL INSTRUMENTS

**Dental Crown Removers**

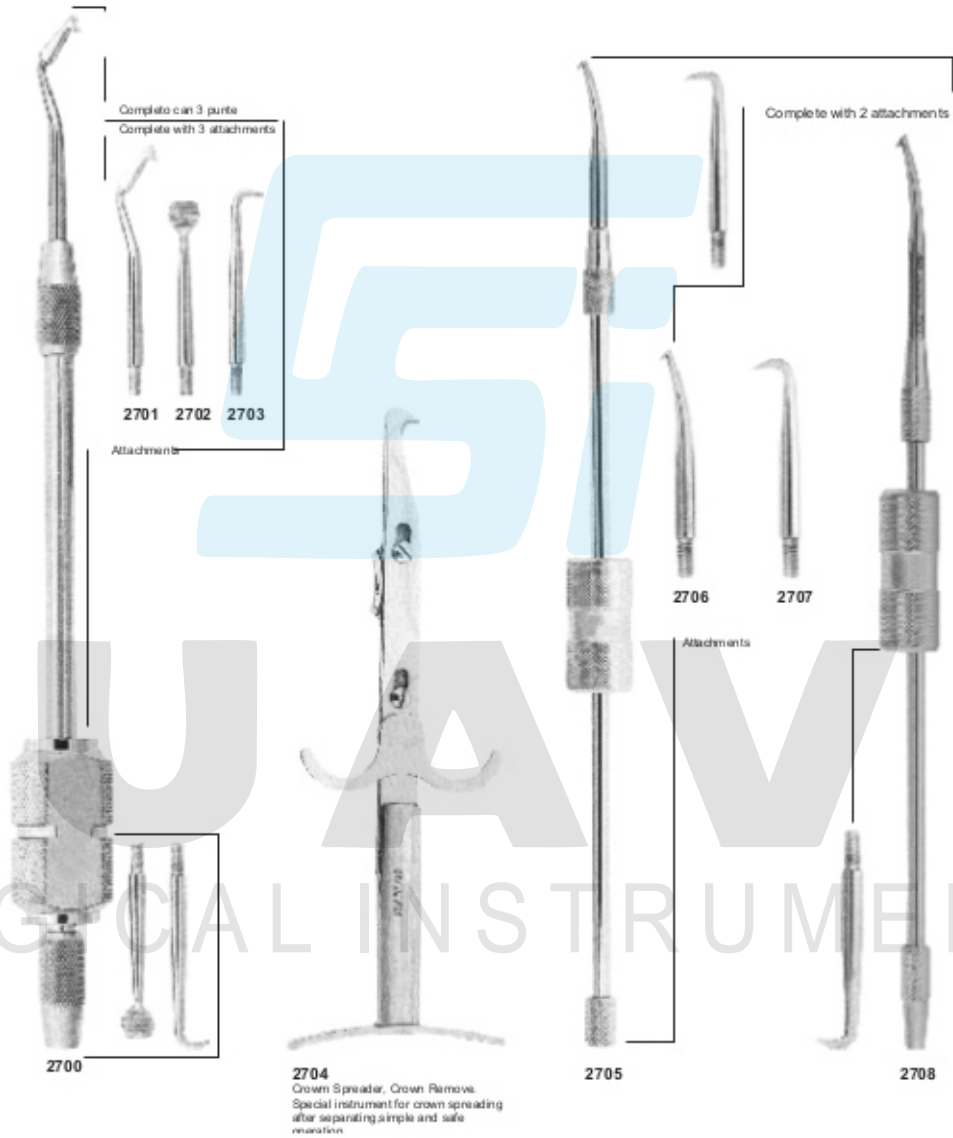

**RASOOL PUR BHALIAN, LALO KAY, SIALKOT - PAKISTAN**

www.suavesurgical.com  
info@suavesurgical.com  
suavesurgical1988@gmail.com



**SUAVE**<sup>®</sup>  
SURGICAL INSTRUMENTS

**Dental Crown Removers, Scissors  
Forceps, Amalgum Guns & Carriers**

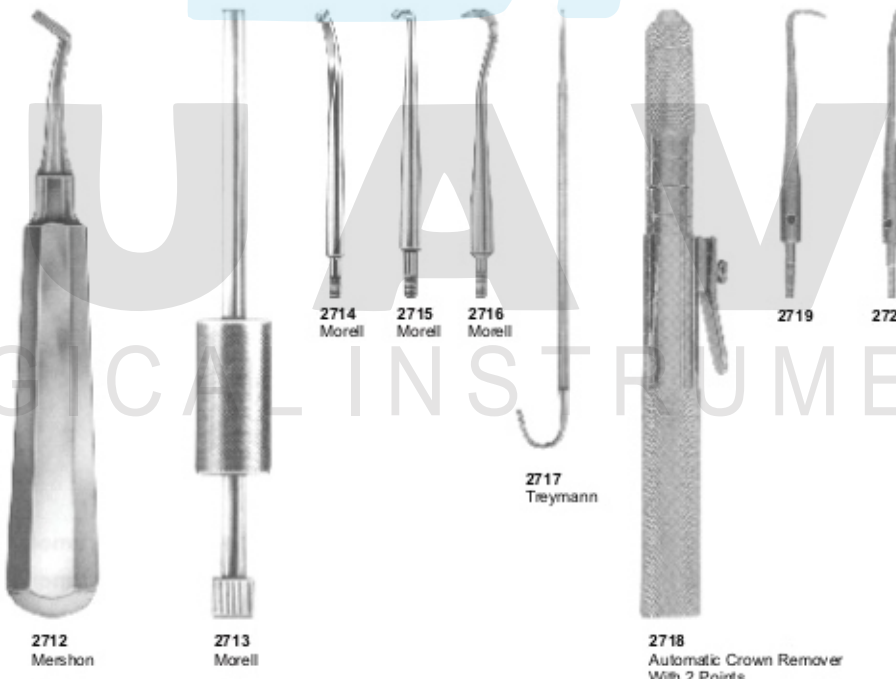
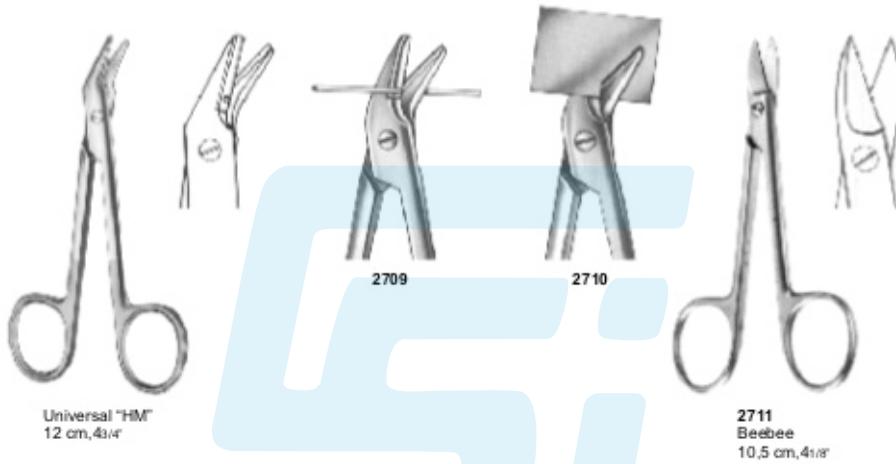

**Amalgam Guns and Carriers**



**SUAVE**<sup>®</sup>  
SURGICAL INSTRUMENTS

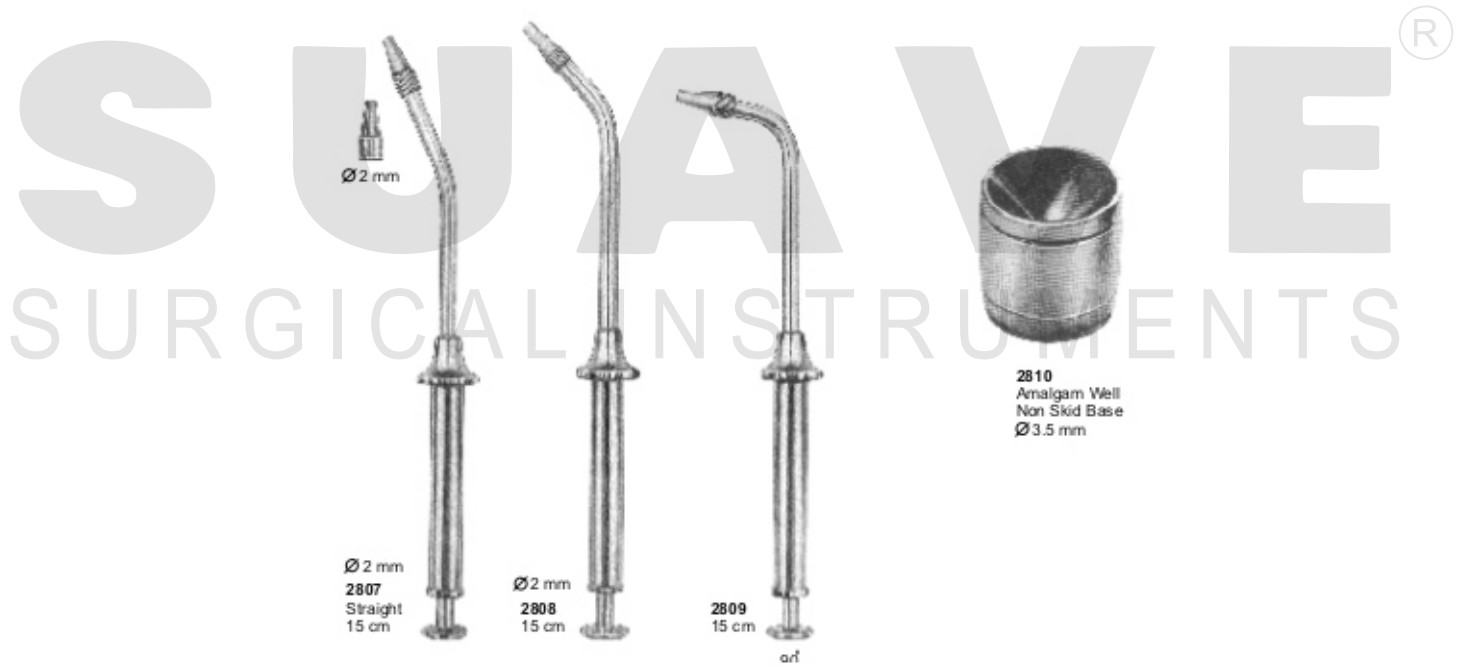
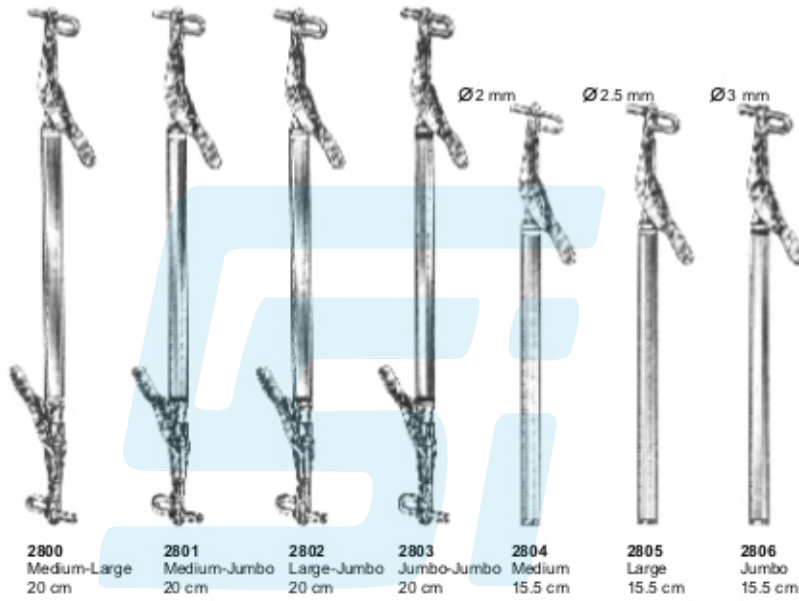

**Copper Ring Removing Pliers,  
Paper Articulator Forceps**



**SUAVE**<sup>®</sup>  
SURGICAL INSTRUMENTS

Copper ring removing pliers

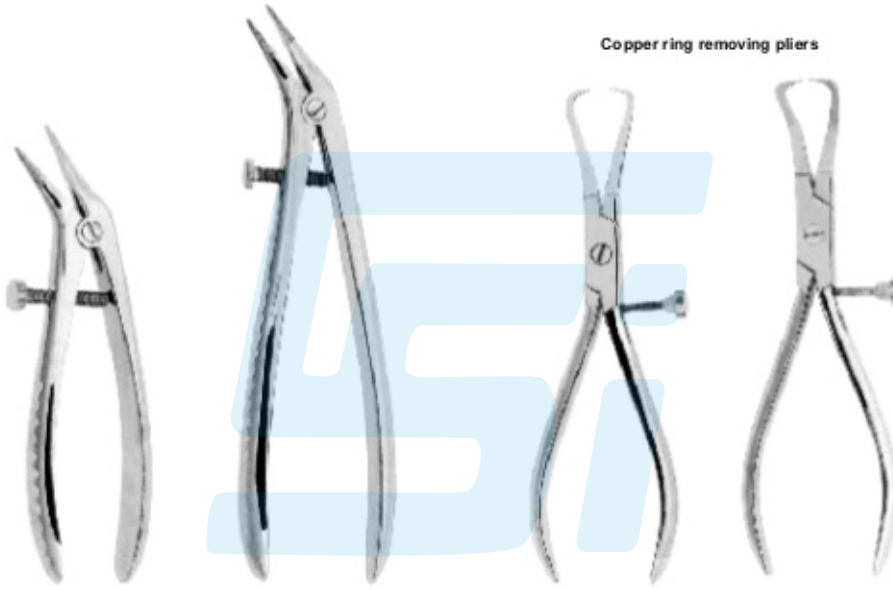

2900  
Bohm  
11,5 cm

2901  
Bohm  
14,5 cm

2902  
Furrer  
16 cm

2903  
Furrer  
16 cm

SUAVE<sup>®</sup>  
SURGICAL INSTRUMENTS

2904  
Miller  
15 cm

2905  
Miller  
15 cm

2906  
Kelly  
14 cm

2907  
Halstead-Mosquito  
12 cm

2908  
Micro-Mosquito  
10 cm



**Rongeurs**



**SUAVE**<sup>®</sup>  
SURGICAL INSTRUMENTS

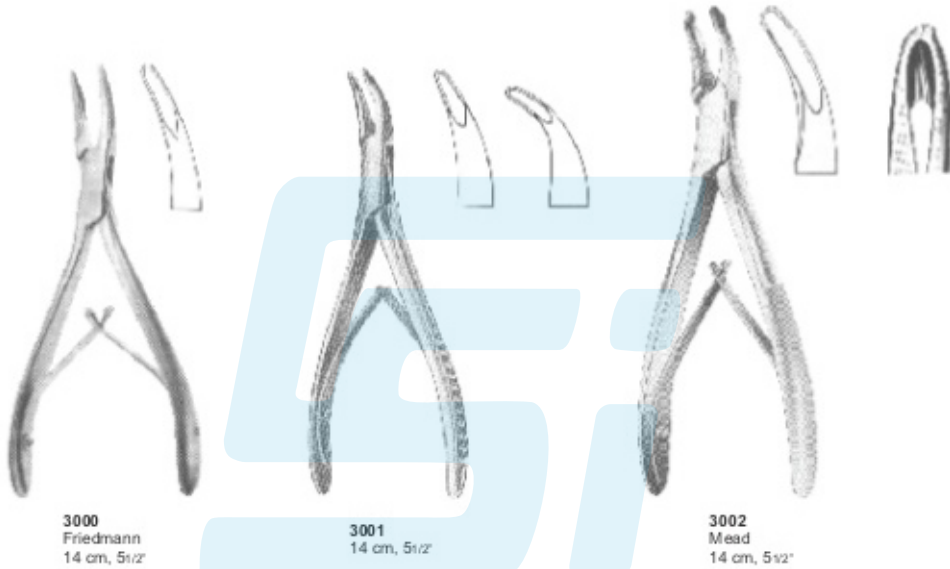

**3000**  
Friedmann  
14 cm, 5 1/2"

**3001**  
14 cm, 5 1/2"

**3002**  
Mead  
14 cm, 5 1/2"

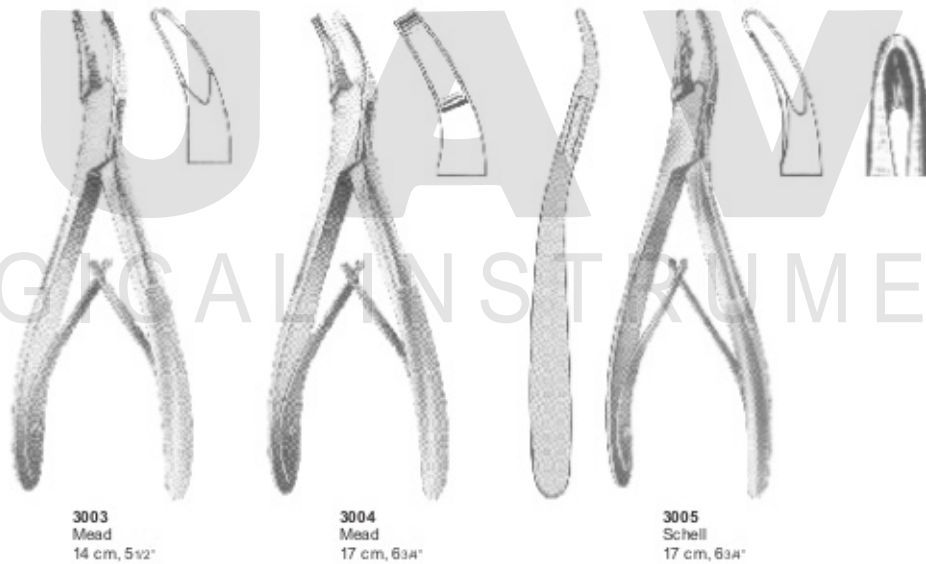

**3003**  
Mead  
14 cm, 5 1/2"

**3004**  
Mead  
17 cm, 6 3/4"

**3005**  
Schell  
17 cm, 6 3/4"





**SUAVE**<sup>®</sup>  
SURGICAL INSTRUMENTS

**Bone Rongeurs**



**3006**  
Luer  
15 cm



**3007**  
Friedman  
14 cm

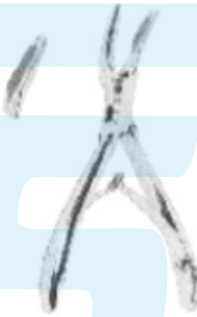

**3008**  
Mini Friedman  
12 cm



**3009**  
Goldman-Fax  
10 cm



**3010**  
Blumenthal  
15 cm

**SUAVE**<sup>®</sup>  
SURGICAL INSTRUMENTS



**3011**  
Blumenthal 45  
14,5 cm



**3012**  
Blumenthal 90  
14 cm



**3013**  
Bohler  
15 cm



**3014**  
Kerrison  
15 cm





**Rongeurs**



3015  
Blumenthal  
16 cm, 6 1/4"



3016  
Blumenthal  
16 cm, 6 1/4"



3017  
Blumenthal  
16 cm, 6 1/4"



3018  
Kleinert-Kutz  
14 cm, 5 1/2"



3019  
Ruskin-Mini  
15 cm



3020  
Beyer  
18 cm, 7 1/8"



3021  
Zaufal-Jansen  
18 cm, 7 1/8"







**SUAVE**<sup>®</sup>  
SURGICAL INSTRUMENTS

**Rongeurs**



3022  
Niro  
No. 5 S, 14 cm, 5 1/2"



3023  
Cleveland  
No. 5 S, 17 cm, 6 3/4"

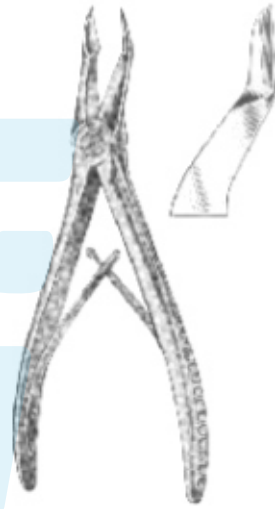

3024  
No. 18, 15 cm, 6"



3025  
Cleveland  
16 cm, 6 1/4"



3026  
Gardner  
16 cm, 6 1/4"



3027  
Liston-mini  
15 cm, 6"



**RASOOL PUR BHALIAN, LALO KAY, SIALKOT - PAKISTAN**

www.suavesurgical.com  
info@suavesurgical.com  
suavesurgical1988@gmail.com



**SUAVE**<sup>®</sup>  
SURGICAL INSTRUMENTS

**Bone Elevators**

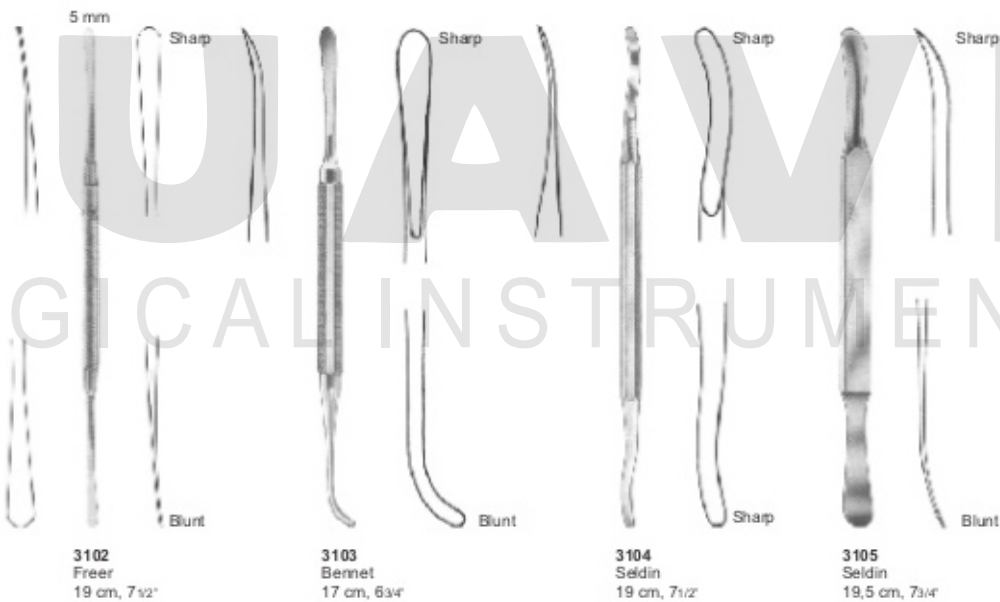
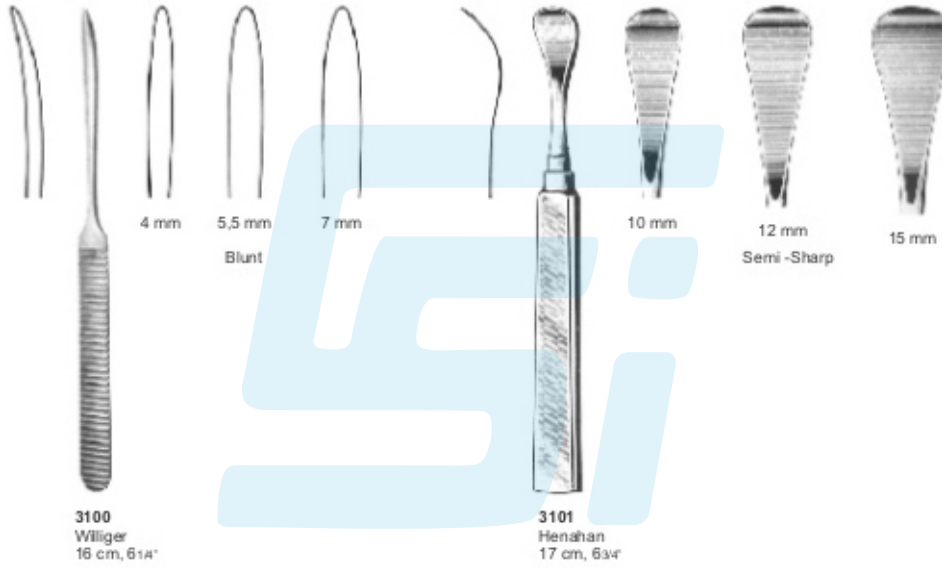



**SUAVE**<sup>®</sup>  
SURGICAL INSTRUMENTS

**Bone File And Chisels**

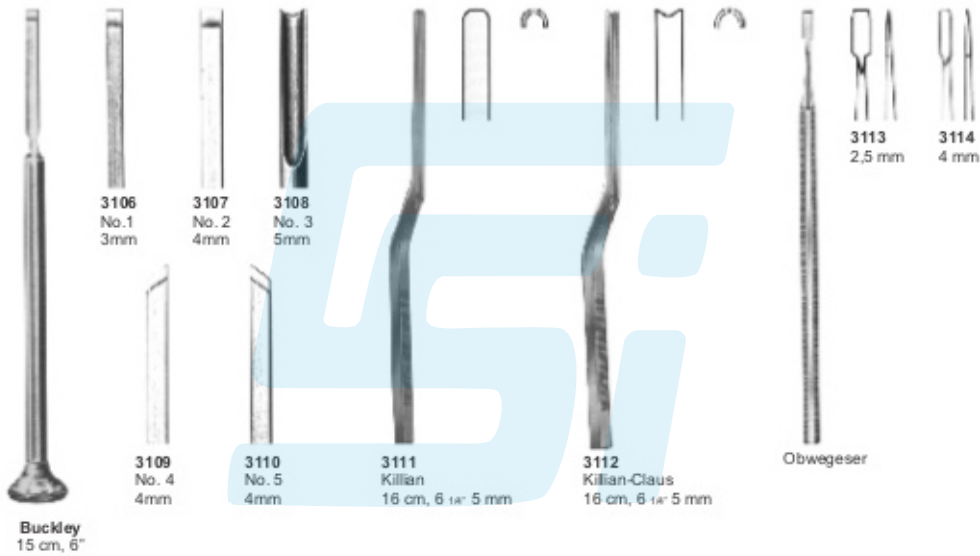

**SUAVE**<sup>®</sup>  
SURGICAL INSTRUMENTS

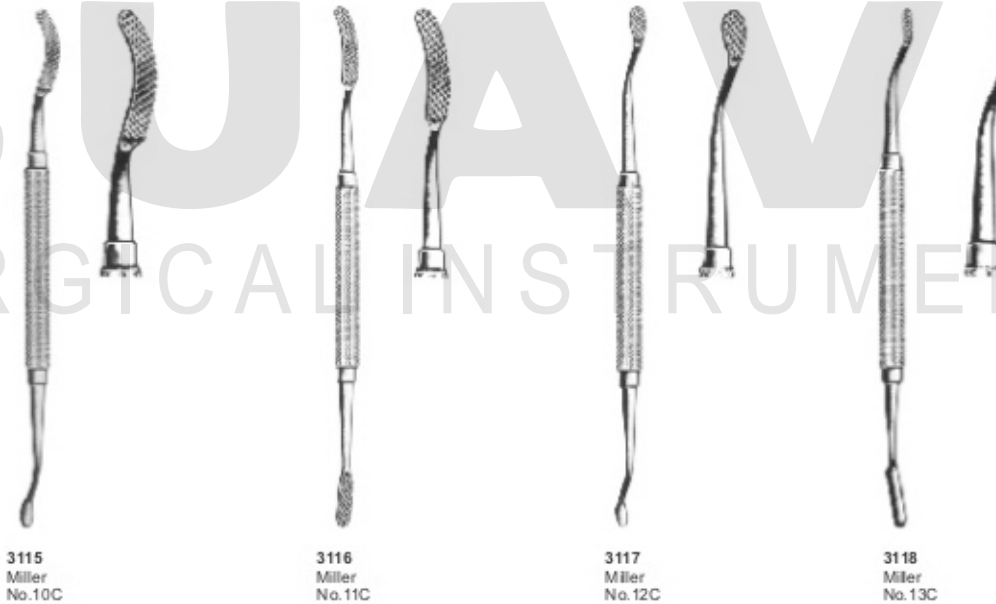



**SUAVE**<sup>®</sup>  
SURGICAL INSTRUMENTS

**Pliers for Orthodontics**

Pinze per formare loops  
Loops forming pliers



**3200**  
Adams  
Adams pliers for bending  
wires up to 0,7 mm. (.28").



**3201**  
Adams  
Adams pliers for bending  
wires up to 0,7 mm. (.28").

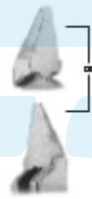

**3202**  
Adams  
Tweed loop forming pliers.  
For forming loop in wires up  
to 0,56 mm. (.22").



**3203**  
Adams  
Aderer three jaws bending  
pliers. For wires up  
to 0,7 mm. (.28").



**3204**  
Adams  
Aderer three jaws bending  
pliers. For wires up to 0,7 mm.  
(.28").





**SUAVE**<sup>®</sup>  
SURGICAL INSTRUMENTS

**Pliers for Orthodontics**

Ligature Cutter Pliers



3205

Micro-miniature light wire cutter. It cuts soft ligature wires. For use in case of limited access. Caution: maximum cutting capacity: soft ligature wire up to 0,30 mm. (.012").



3206

Wire cutter. For ligature wires and pins. It is strong enough to bend archwire ends after distal cutting. Maximum cutting capacity up to 0,56 x 0,7 mm. (.022" x .028").



3207

Wire cutter. For ligature wires and pins. It is strong enough to bend archwire ends after distal cutting. Maximum cutting capacity: up to 0,9 mm. (.036").



3208

Wire cutter. For ligature wires and pins. It is strong enough to bend archwire ends after distal cutting. Maximum cutting capacity: up to 1,5 mm. (.044").



**RASOOL PUR BHALIAN, LALO KAY, SIALKOT - PAKISTAN**

www.suavesurgical.com  
info@suavesurgical.com  
suavesurgical1988@gmail.com



**SUAVE**<sup>®</sup>  
SURGICAL INSTRUMENTS

**Pliers for Orthodontics**

Pinze per formare laboratorio  
Laboratory pliers



3210

Bending wires up to 0,7 mm. (.028").

3211

Bending wires up to 0,7 mm. (.028").

3209

Flat nose pliers with smooth beaks for bending wires up to 0,7 mm. (.028").

3212

Bending wires up to 0,7 mm. (.028").



**RASOOL PUR BHALIAN, LALO KAY, SIALKOT - PAKISTAN**

www.suavesurgical.com  
info@suavesurgical.com  
suavesurgical1988@gmail.com





**SUAVE**<sup>®</sup>  
SURGICAL INSTRUMENTS

**Pliers for Orthodontics**

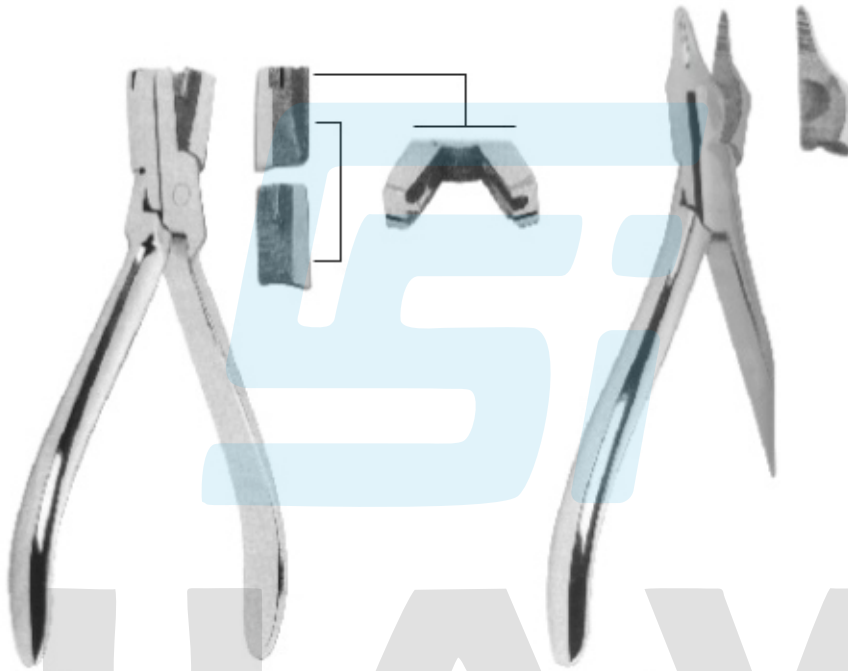

**3213**  
Nance  
Nance loop closing pliers for bending of stop loops and special for Adams' clasps. Wires up to 0,7 mm. (.028").

**3214**  
Nance  
Universal pliers for bending wire up to 0,9 mm. (.035") or cutting up to 0,7 mm. (.028").

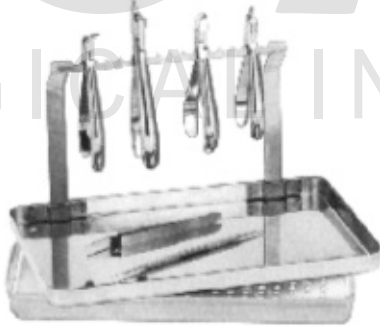

**3215**  
Stainless steel pliers tray standard dimensions



**3216**  
Universal  
Universal pin roughening, cutting and bending pliers. For wires up to 0,9 mm. (.035"). Will cut wires up to 0,7 mm. (.028").



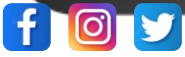

**SUAVE**<sup>®</sup>  
SURGICAL INSTRUMENTS

**Pliers for Orthodontics**

Utility and specialty pliers



**3217**  
Reynolds  
Reynolds contouring pliers.



**3218**  
Reynolds  
Lingual arch pliers used to form double and triple back bends in 0.7 mm (.028") or 0.9 mm (.035") wire for insertion in lingual sheaths.



**3219**  
Weingart  
Weingart pliers with serrated points.

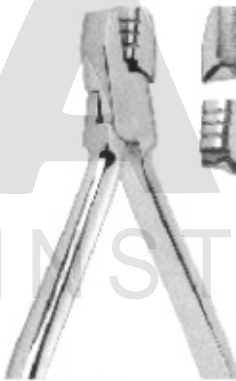

**3220**  
De La Rosa  
De La Rosa arch forming pliers. Designed to form and contour arch wires on round or rectangular wire. The beak has grooves of 0.4 mm (.016"), 0.46 mm (.018") and 0.56 mm (.022").



**3221**  
De La Rosa  
Arch forming pliers with a non grooved contouring surface the forming of precise arches.



**RASOOL PUR BHALIAN, LALO KAY, SIALKOT - PAKISTAN**

[www.suavesurgical.com](http://www.suavesurgical.com)  
[info@suavesurgical.com](mailto:info@suavesurgical.com)  
[suavesurgical1988@gmail.com](mailto:suavesurgical1988@gmail.com)



**SUAVE**<sup>®</sup>  
SURGICAL INSTRUMENTS

**Pliers for Orthodontics**

**Distal end cutters**

**D.B. bracket remover pliers**



**3227**

Distal end cutter -safety hold- a precision cutter designed for distal arch cutting in the patient's mouth. It cuts hard wires and holds the loose distal end preventing any damaging of oral tissue. Maximum cutting capacity rectangular wires up to 0,56 x 0,7 mm. (.022" x .020").



**3228**

Micro-distal end cutter - safety hold. Similar to 3227



**3229**

Direct bonding bracket remover (wide). The removal grip firmly for easy incisal-gingival (vertical) use or, if needed, for mesial-distal (horizontal) use with the same ease.



**3230**

Direct bond attachment remover (angled). For removing all bonded attachments. May be used mesial-distal-horizontal) or incisal-gingival (vertical) in anterior areas. Angled perfectly for easy access to difficult posterior areas.





**SUAVE**<sup>®</sup>  
SURGICAL INSTRUMENTS

**Pliers for Orthodontics**

Bird beak pliers



**3231**  
Wire bending pliers. For wires up to 0.9 mm. (.036").

**3232**  
Bird Beak Angle pliers for bending round, square or rectangular wire up to 0.7 mm. (.028").

**3233**  
Double rounded jaw wire bending pliers. For wires up to 0.7 mm. (.028").

**3234**  
Bird beak pliers for bending round, square or rectangular wire up to 0.7 mm. (.028"). With cutter.

**3235**  
Double rounded jaw wire bending pliers. For wires up to 0.7 mm. (.028").





**SUAVE**<sup>®</sup>  
SURGICAL INSTRUMENTS

**Pliers for Orthodontics and Prosthetics**

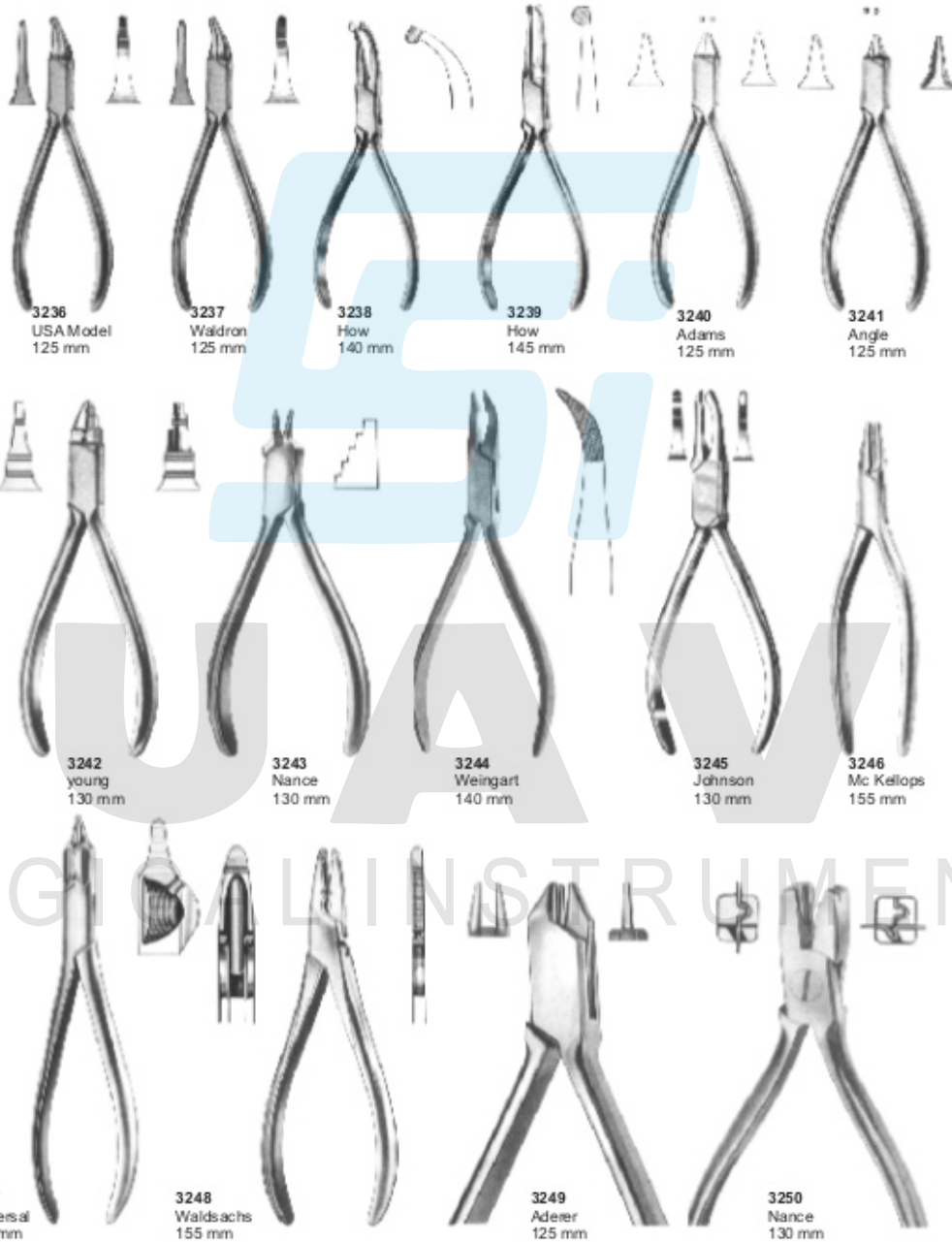

3236  
USA Model  
125 mm

3237  
Waldron  
125 mm

3238  
How  
140 mm

3239  
How  
145 mm

3240  
Adams  
125 mm

3241  
Angle  
125 mm

3242  
young  
130 mm

3243  
Nance  
130 mm

3244  
Weingart  
140 mm

3245  
Johnson  
130 mm

3246  
Mc Kellops  
155 mm

3247  
Universal  
150 mm

3248  
Waldsachs  
155 mm

3249  
Aderer  
125 mm

3250  
Nance  
130 mm



**SUAVE**<sup>®</sup>  
SURGICAL INSTRUMENTS

**Pliers for Orthodontics and Prosthetics**







**Pliers for Orthodontics and Prosthetics**



3269



3270



3271



3272



3273



3274



3275



3276



3277



3278



3279



3280



3281



3282



3283



3284



3285



3286

SUAVE<sup>®</sup>  
SURGICAL INSTRUMENTS



**SUAVE**<sup>®</sup>  
SURGICAL INSTRUMENTS

**Stainless Steel Impression Trays**

All Impression Trays Upper & Lower Type  
are available in S, M, L & XL Sizes



**3300**  
"HYDRO-LOCK"  
stainless steel  
water-cooled  
impression trays  
with retention rim.



**3301**  
"HYDRO-LOCK"  
stainless steel  
water-cooled impression  
trays with retention rim.



**3302**  
"NEW SUPER"  
stainless steel  
impression trays  
with retention rim.



**3303**  
"NEW SUPER" stainless  
steel impression trays  
with retention rim.



**3304**  
"ANATOMIC" solid  
regular stainless  
steel impression  
trays without  
retention rim.



**3305**  
"ANATOMIC" solid regular  
stainless steel impression  
trays without retention rim.

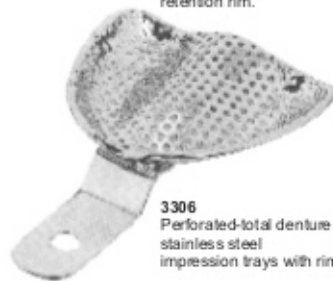

**3306**  
Perforated-total denture  
stainless steel  
impression trays with rim.



**3307**  
Perforated-total denture  
stainless steel  
impression trays with rim.





**SUAVE**<sup>®</sup>  
SURGICAL INSTRUMENTS

**Stainless Steel Impression Trays**

All Impression Trays Upper & Lower Type  
are available in S, M, L & XL Sizes



**3308**  
"PERMA-LOCK" solid regular stainless steel impression trays with retention rim.



**3309**  
"PERMA-LOCK" solid regular stainless steel impression trays with retention rim.



**3310**



**3311**



**3312**



**3313**



**3314**



**3315**



**3316**  
Set of six

**PACKINGS**



**3317**  
Set of Eight



**3318**  
Solid stainless steel anterior depressed impression trays with retention rim.



**3319**



**3320**



**3321**



**3322**



**3323**



**3324**



**3325**  
Solid stainless steel anterior depressed impression trays with retention rim.



**Stainless Steel Impression Trays**



All Impression Trays Upper & Lower Type  
are available in S, M, L & XL Sizes



3326  
Fig. 0 per bambini - for children



3327  
For narrow toothed upper jaws



3328  
Fig. 0 per bambini - for children



3329  
For partially toothed upper jaws



3330  
For partially toothed lower jaws



3331  
For edentulous upper jaws



3332  
For edentulous lower jaws

SUAVE<sup>®</sup>  
SURGICAL INSTRUMENTS





**Stainless Steel Impression Trays**



**SUAVE**<sup>®</sup>  
SURGICAL INSTRUMENTS

All Impression Trays Upper & Lower Type  
are available in S, M, L & XL Sizes



**3333**  
Solid total denture stainless steel impression tray with rim.

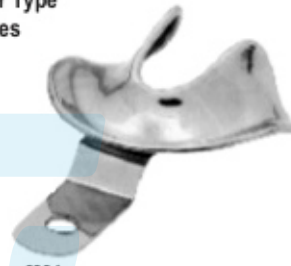

**3334**  
Solid total denture stainless steel impression tray with rim.



**3335**  
"PERMA-LOCK" perforated regular stainless steel impression trays with retention rim.



**3336**  
"PERMA-LOCK" perforated regular stainless steel impression trays with retention rim.



**3337**  
Perforated stainless steel anterior depressed impression trays with retention rim.

**3338**

**3339**

**3340**

**3341**

**3342**

**3343**

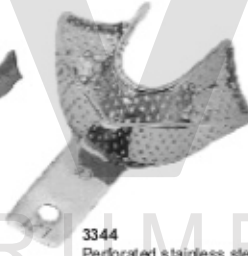

**3344**  
Perforated stainless steel anterior depressed impression trays with retention rim.



**3345**  
Perforated stainless steel impression trays without retention rim for complete denture.



**3346**  
Perforated stainless steel impression trays without retention rim for complete denture.



**RASOOL PUR BHALIAN, LALO KAY, SIALKOT - PAKISTAN**

[www.suavesurgical.com](http://www.suavesurgical.com)  
[info@suavesurgical.com](mailto:info@suavesurgical.com)  
[suavesurgical1988@gmail.com](mailto:suavesurgical1988@gmail.com)



**Articulators**



**SUAVE**<sup>®</sup>  
SURGICAL INSTRUMENTS

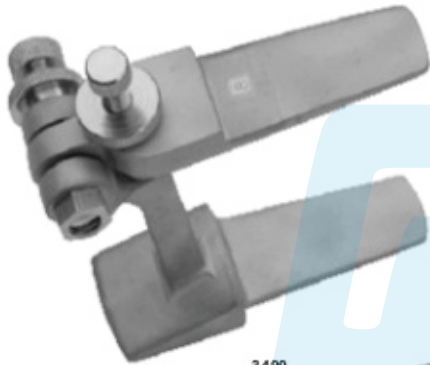

3400



3401



3402



3403

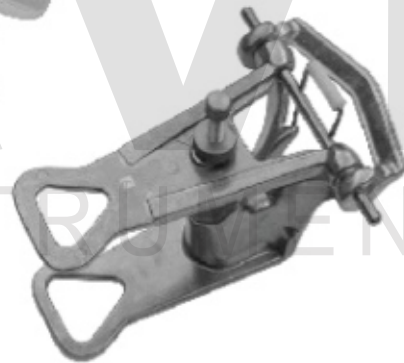

3404



3405



**RASOOL PUR BHALIAN, LALO KAY, SIALKOT - PAKISTAN**

www.suavesurgical.com  
info@suavesurgical.com  
suavesurgical1988@gmail.com



**Articulators**



**SUAVE**<sup>®</sup>  
SURGICAL INSTRUMENTS

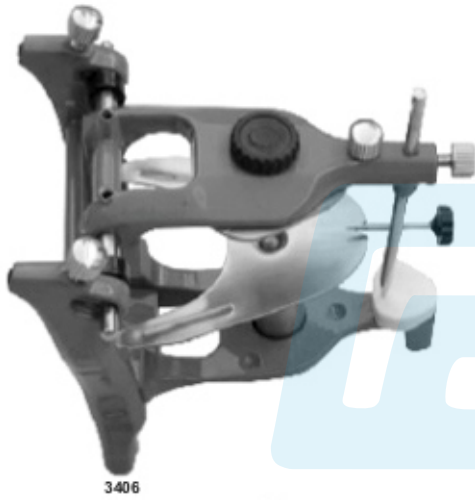

3406



3407



3408

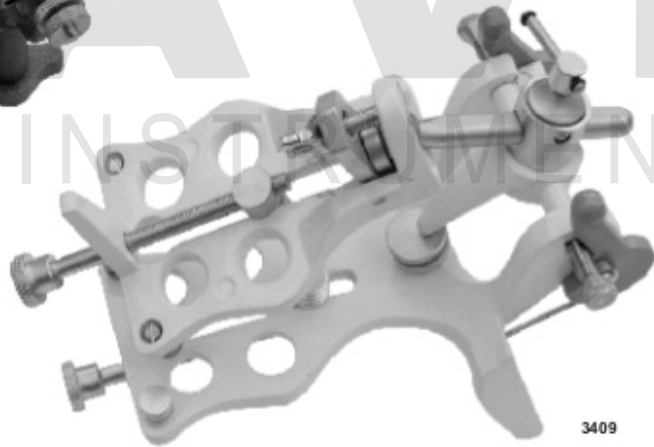

3409



**Dental & Surgical Hollowares**

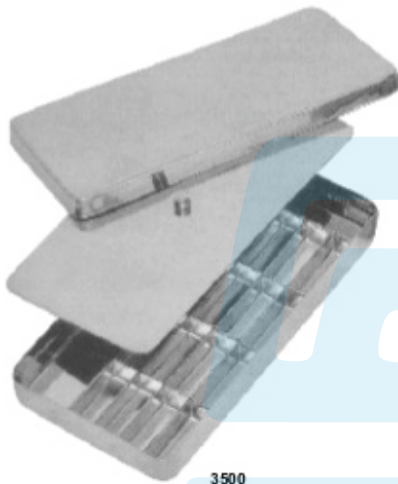

3500  
ENDODONTIC BOX

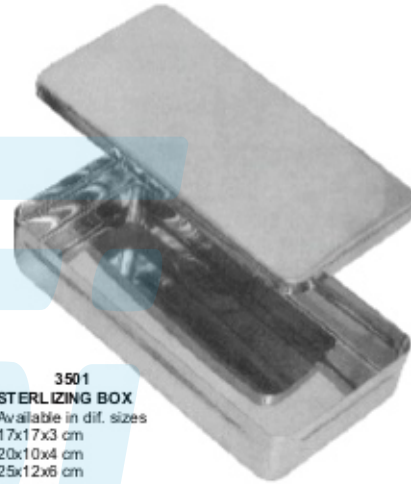

3501  
STERILIZING BOX  
Available in dif. sizes  
17x17x3 cm  
20x10x4 cm  
25x12x6 cm  
30x14x6 cm



3502  
ENDO TRAY BOX

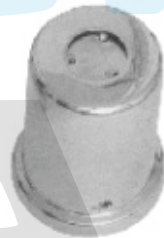

3503  
COTTON DISPENSER

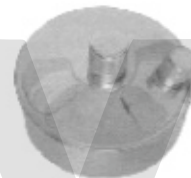

3504  
ALCOHOL LAMP

**Sterilizing Drums**



3505



3506



3507





**SUAVE**<sup>®</sup>  
SURGICAL INSTRUMENTS

**Dental & Surgical Hollowares**

Sterilizing Boxes

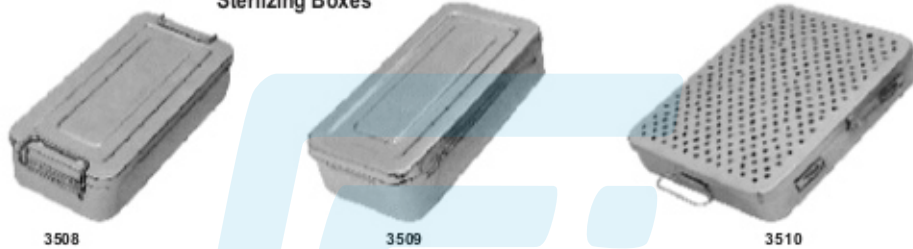

3508

3509

3510

Sterilizing Boxes

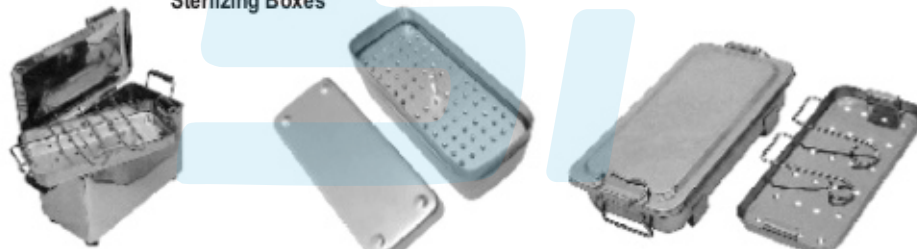

3511

3512

3513



3514

3515

FORCEP AND THERMOMETER JARS



3516

COTTON DISPENSER



3517

IRRIGATOR(Douch can)



3518

MEASURING JUG



3519

KIDNEY TRAY





**SUAVE**<sup>®</sup>  
SURGICAL INSTRUMENTS

**Dental & Surgical Hollowares**



3520  
FORCEP JAR



3521



GALLIPOT WITH & WITHOUT LID



3522

SPITTEN MUG



3523

SPIRIT LAMP

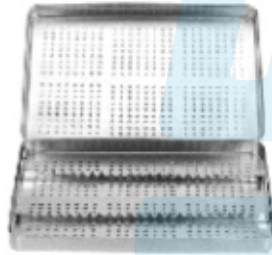

3524  
Perforated Tray



3525  
Perforated Base



3526  
Solid Base



3527  
Instruments Tray

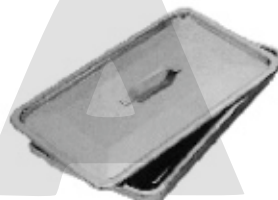

3528  
Instruments Tray

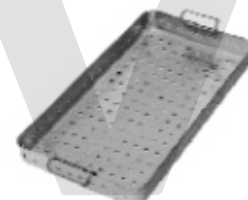

3529  
Instruments Tray  
(Perforated)



3530  
Instruments Tray Shallow  
(Mayo)



3531  
Scalars Tray



3532  
Cathetar Tray





**SUAVE**<sup>®</sup>  
SURGICAL INSTRUMENTS



**RASOOL PUR BHALIAN,  
LALO KAY, SIALKOT - PAKISTAN**

[www.suavesurgical.com](http://www.suavesurgical.com)

[info@suavesurgical.com](mailto:info@suavesurgical.com)

[suavesurgical1988@gmail.com](mailto:suavesurgical1988@gmail.com)



**+92-346-6623928**

